

Instructions for startup, operation and maintenance

Applicable to:

Small wastewater treatment system one2clean plus

Control unit version

KLcontrol.S

KLcontrol.M



Intended and safe use requires you to heed the instructions and other information in this documentation.

Read carefully the instructions for use before installation, assembly, and startup, and keep these in a safe place for future reference.

Instructions for one2clean plus wastewater treatment plant

EAN-Nr. 4023122276241, Version 1
Date issued 17.06.2021
Original operating instructions
Original language: German

Otto Graf GmbH Kunststoffzeugnisse
Carl-Zeiss-Straße 2–6, 79331 Teningen
Germany

Tel.+49 7641 589-0
mail@graf.info www.graf.info

Contents

1	About these instructions.....	2
2	Safety.....	4
3	General.....	9
4	The wastewater treatment system's control unit.....	17
5	Initial use.....	33
6	Operating instructions.....	35
7	Operation and maintenance.....	38
8	Service menu for authorised specialist.....	45
9	Additional controller functions.....	55
10	Fault messages and rectification.....	74
11	Disposing of the controller.....	81
12	Declarations, attestations, certificates.....	82
13	Annex I: Template for weekly / monthly check notes.....	84
14	Maintenance log for GRAF wastewater treatment systems.....	87
15	Notes.....	89

1 About these instructions

This Technical Documentation for the wastewater treatment system is divided into several sections. This documentation forms an integral part of the product and must be handed over to the new owner or at the new site. The full Technical Documentation comprises:

- installation instructions for the underground tank
- installation instructions for the wastewater treatment plant
- instructions for startup, operation, and maintenance
- technical data, circuit diagrams, and documentation provided by parts suppliers

All persons coming into direct contact with the plant must have read and understood the contents of this documentation.

This section contains the startup, operating, and maintenance instructions. These are intended for all persons handling the plant, and are prefaced with a description of the plant and its functions as well as details pertaining to its handling safety and potential residual risks. These are followed by details on the available switch and machine cabinets and their positions; a description of the controller and its functions; and instructions for its startup. Concluding these are instructions on how to operate and service the plant and a description of the fault messages, together with troubleshooting instructions. We recommend keeping this section in the vicinity of the plant.

Copyright

These instructions for use contain copyrighted information and figures. Otto Graf GmbH Kunststoffzeugnisse reserves all rights. No part of these instructions for use may be duplicated, reproduced, used for other purposes, or translated into any language without the prior, explicit consent issued in writing by Otto Graf GmbH Kunststoffzeugnisse.

1 About these instructions

1.1 Typeface conventions

These instructions for use make use of the following typeface conventions.

Format	Meaning
<i>Italic text</i>	This refers the reader to other contents in this document, other sections of the instructions for use, or additional information. Digitised media (e.g. PDFs) present links to the destinations that the user can click or tap directly.
»...«	This reproduces lettering or a label on the product or component.
[...]	This represents a key or switch.

1.2 Symbols and signal words

These instructions for use make use of the following symbols. An overview of the safety symbols and signal words used can be found in *Subsection 2.1.1*.

Symbol	Signal word and meaning
	IMPORTANT / TIP / INFO This highlights important information, tips, and other particularly useful details

2 Safety

Despite all safety precautions, the plant may nevertheless pose some degree of residual risk, particularly when handled incorrectly or negligently. To protect yourself and others from all danger and to prevent damage and pollution as a result of incorrect handling, therefore, please read and follow the safety and other instructions in both this and the other sections making up the instructions for use.



WARNING

Failure to heed the safety instructions may cause accidents and damage.

- The consequences can extend to serious, and even fatal injury and harm to health.
 - Read and follow both the safety and the other instructions.
-

2.1 General safety instructions

2.1.1 Safety symbols and signal words

The following safety symbols and signal words are used in these instructions for use and on the plant's components:



DANGER

This highlights imminent danger. Failure to observe this will cause death or grievous injury.



WARNING

This highlights a potentially hazardous situation. Failure to observe this may cause death or grievous injury.



CAUTION

This highlights a potentially hazardous situation. Failure to observe this may cause slight or minor injury.

IMPORTANT

This highlights a scenario that may cause pollution to the environment or damage to the product or nearby property.



This highlights potential risks from electricity.



This highlights a potential risk of falling.



This highlights potential risks from hot surfaces.



This highlights potential risks from optical radiation.

2.1.2 Intended use

The SBR plant has been designed to channel domestic wastewater from private homes. Domestic wastewater contains faeces and other substances found in bath, washing, sink, and mop water such as soap, detergent, and food scraps.

The SBR plant may also be used to channel other wastewater types (e.g. from restaurants, dairies, winemakers, breweries, and other commercial establishments) when this purpose was known at the time of and incorporated in the plant's layout.

2.1.3 Incorrect use

The SBR plant may be used only for the purposes described in these instructions. The plant may not be used for industrial wastewater. Under no circumstances may the plant be used to channel biocides, toxic substances, or substances which are not biocompatible: these hinder bacteria important to wastewater cleaning and cause problems in the biological process.

A detailed list of substances that may not be channelled through the plant can be found in *Sub-section 6*.



WARNING

- Failure to use the plant for its intended purpose may cause harm to health, pollution to the environment, and damage to property.
-

2.2 Safety instructions for the operator

The operator of the plant is responsible for its correct installation and operation. He is also responsible for ensuring adherence to the safety and other instructions in this section, but also to

the laws, standards, rules, and regulations pertaining to the plant's site. These include in particular the health and safety, accident prevention, and environmental protection regulations as well as the inspection and maintenance specifications applying to the plant's site.

To meet official cleaning requirements, it is essential that the plant is operated in accordance with the operating and maintenance instructions.

Operator's obligations

In order to maintain the plant's operating safety, the operator must:

- (re)configure and inspect the plant at the prescribed regular intervals and maintain an operating log book (*see Subsection 7.2*)
- commission a specialist to service the plant at the prescribed regular intervals
- Immediately on signs of damage to the controller or wiring, the plant must be shut down and disconnected from the power supply.
- Malfunctions and damage must be remedied immediately or repaired by a specialist
- All safety labels on the plant must be maintained in an easily legible condition at all times.

2.2.1 Personnel qualifications

The operator must make sure that the installation, assembly, inspection, and maintenance personnel are adequately qualified or possess the adequate knowhow for their assigned tasks, and all persons handling the product have received adequate instruction. The requisite qualifications may be subject to additional regulations.

The plant must not be operated by anyone under the influence of alcohol, narcotics, or medication that limits cognitive ability or ability to react.

Installation, care, maintenance

Only specialists may perform care and maintenance work on the plant. Specialists are those persons whose professional training and qualifications render them suitable for operating and servicing wastewater treatment systems. Only specialised electricians may be assigned to work on the electrical installations and to connect the plant to its power supply.

2.3 General safety measures

- ▶ **Keep tank covers closed at all times. Never leave open tank covers unattended.**
 - Tank covers may be opened for inspection and maintenance purposes only. There is a danger of persons or animals falling into the tank. This may result in serious injury or drowning.
 - Keep unassigned persons, in particular children, away from open tank covers.
 - Closed tank covers must resist all attempts by a child to open them.
Before closing, make sure that there are no persons or animals in the tank.

2 Safety

- ▶ **Keep switch cabinets closed at all times. Never leave an opened switch cabinet unattended.**
 - Switch cabinets house components that may be hot to the touch. Touching these may cause burning injuries.
 - Unauthorised access to the controller may cause serious malfunctions.
 - Open the switch cabinet only for the purpose of operating or servicing the plant.
 - At the end of the work, close and lock the cabinet.
- ▶ **Operate the controller only when it is in perfect working condition**
 - Any damage, however slight, to the controller's housing or the wiring insulation poses a risk of electric shock.
 - Immediately on signs of damage, shut down the plant, disconnect it from its power supply, and commission a specialist for its repair.
- ▶ **Do not place any receptacles containing liquids on the switch cabinet.**
 - Spilled or discharging liquids may cause short circuits. Fire or electric shock may be the consequence.
- ▶ **Do not transport or deposit any substances hazardous to water near the tank cover.**
- ▶ **Wear personal protective equipment (PPE)**
 - PPE (protective gloves, goggles, safety shoes, etc.) protects the wearer against injury and harm to health.
 - Whenever necessary, wear the prescribed protective equipment.
 - Do not use damaged or defective protective equipment, which must be replaced immediately with fully functional equivalents.

2.4 Safety measures for inspection and maintenance

- ▶ **Do not consume any food or drink when operating or working at or on the plant.**
 - Edibles coming into contact with microbes may carry and cause infection.
- ▶ **Shutting down the plant's installations and equipment.**
 - Equipment may start to operate unexpectedly. Damaged wiring poses a risk of electric shock.
 - Before all repair, maintenance, and cleaning work on the plant, shut it down completely, including all of its installations, and secure it against reactivation.
 - Disconnect the electrical installations from their power supplies.
- ▶ **Only specialised electricians may be assigned to work on the electrical installations and to connect the plant to its power supply.**
 - Danger from electric shock.
- ▶ **Handle chemicals properly.**
 - Chemicals can cause poisoning, harm to health, and caustic injuries.
 - Consult their manufacturers' safety data sheets for details.
 - Whenever necessary, wear PPE.
 - Keep chemicals safely away from children and unauthorised access.

2.4.1 Safety measures for work inside the tank

Harmful gases may form inside wastewater treatment systems. The wastewater may carry pathogens and substances harmful to health. The plant's tanks and shafts may be accessed bodily for repair and maintenance work only.

- ▶ **Verify that work in the tank is necessary.**
 - Always examine first whether this work may be performed from outside, e.g. inspections with a remote controlled camera.
- ▶ **Assign a second person to supervise all work.**
 - This second person must remain at the access point. He must remain in constant contact with the person in the tank and be in a position to fetch assistance immediately.
 - Never enter the tank without this second, supervising person.
- ▶ **Empty tank completely**
 - An accident victim can also drown in shallow depths.
 - Never enter a tank, even when it is only partially full.
- ▶ **Provide a supply of healthy air to the tank.**
 - Before being accessed, the tank must first be vented adequately to clear it of any gases.
 - If adequate cross or diagonal venting (chimney effect) cannot be ensured, a supply of air must be provided with equipment.
 - Whenever necessary, measure and monitor constantly the air quality.
- ▶ **Increase access safety and provide an escape route**
 - Use only suitable equipment, e.g. ladder, to access the tank.
 - Make sure that the escape route remains unobstructed.

2.4.1.1 In the event of an accident in the tank

- ▶ **If the accident victim is unconscious, do not under any circumstances attempt to climb in to his rescue.**
 - There is danger of death from asphyxiation or noxious gases.
 - Call the emergency services and follow their instructions.
 - While you are waiting, vent the tank from outside, using e.g. a fan or similar.

3 General

3.1 Details about your plant

In case you have any queries while operating the plant, please enter the details of your plant here as follows. Should you encounter a fault, these details will enable our staff to find a remedy faster.

Your plant's specifications can be found on the type plate. This type plate is affixed to the external housing of internal switch cabinets and inside external switch cabinets.

		Wastewater treatment plant		5 PE	
Sludge store	<input type="text"/>	m ³	Approval	<input type="text"/>	
Buffer	<input type="text"/>	m ³	Discharge class	D+P	
SB-Reactor	3,45	m ³	Tested	<input type="text"/>	
Description		Cabinet	Controller	Compressor	
A-Schrank M KL24+ LA 80 DP24 WL		LA 80		LA 80	
Serial No.	20340682	J-19416736	19232858		
Additional modul	+P	WL	<input type="text"/>		
Typ	one2clean+				
El. power	230 V / 50 HZ 86 W 1~		Safety Class	IP20	
<small>Otto Graf GmbH, Carl-Zeiss-Straße 2-6, DE-79331 Teningen</small>					



Otto Graf GmbH
18
EN-12566-3
Declaration No.
103

Figure 1 – Rating plate for the wastewater treatment system

3.2 Layout and functions

The basic wastewater treatment plant consists of the following components:

- one or multiple tanks
- control cabinet

The wastewater treatment installations in the tanks are connected to the control cabinet via air hoses laid in the ground.

In the wastewater tank you will find:

- membrane pipe diffusers
- outflow lifter in the form of a mammoth pump with its own air supply
- an integrated water sampling point

In the control cabinet, you will find:

- a quiet, low-maintenance air compressor
- a valve unit
- a control unit

3.2.1 Layout of a one-tank system

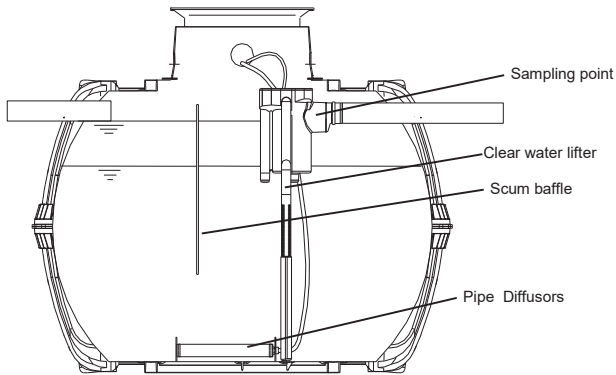

Figure 2 – Example one-tank system in a Carat tank

3.2.2 Layout of a multi-tank system

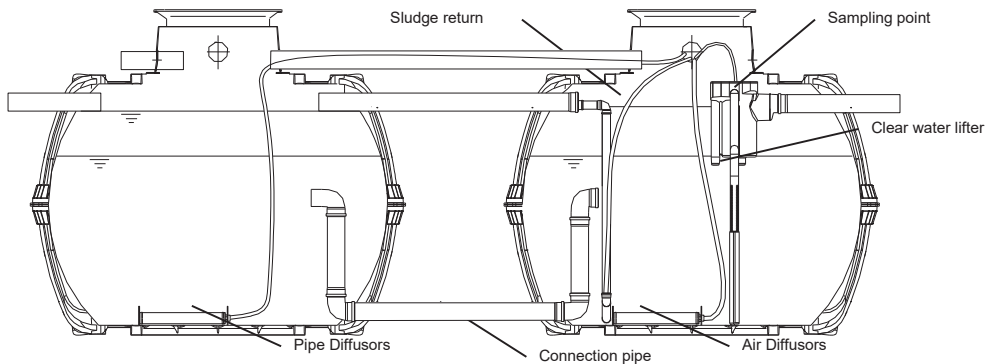

Figure 3 – Example multi tank system in two Carat tanks

3.2.3 Function of the SBR plant

The one2clean plus wastewater treatment system is a fully biological wastewater treatment system and functions on the principle of the retention process with extended aeration (Sequencing Batch Reactor). The system basically consists of an aerobic stage, which is split into a rest and

an aeration zone, linked together in the lower section. This process therefore subjects all the domestic wastewater directly to aerobic wastewater treatment. Blowing in compressed air aerates the entire system and the resultant aerated sludge biologically cleans the wastewater.

The coarse materials and floating solids in the wastewater are initially retained using a scum guard in the rest zone. Then the wastewater passes into the aeration zone via an aperture under the scum guard. The rest zone is aerated too, so the retained solids are also aerobically broken down over the course of time. In the one2clean plus, the wastewater is treated without pre-treatment so no anaerobic putrefaction processes can occur.

The wastewater treatment plant is operated using a microprocessor control, which controls the air compressor and air distribution for the various lifters via magnetic valves / stepped motors.

3.2.3.1 Systems for breaking down the organic matter present in the water (removal of carbon: discharge class C)

The SBR process is a series of 3 steps undertaken in turn and repeated two times a day.

Step 1: Aeration

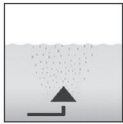

In the first phase, the wastewater is put straight through aerobic treatment for a fixed time. As a result, the microorganisms (aerated sludge) are supplied with the oxygen needed for the breakdown and then pressure aeration causes mixing. The system's aeration equipment is supplied with ambient air by a compressor. Aeration is intermittent so that targeted wastewater cleaning is possible. Different ambient conditions can thereby be achieved.

Step 2: Settle



There is no aeration in the second phase. The aerated sludge and the remaining settleable solids can now settle with the aid of gravity. A clear water zone forms at the top and a sludge layer at the bottom. Any floating sludge is on top of the clear water zone.

Step 3: Clear water extraction

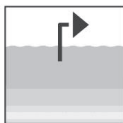

In this phase, the biologically cleaned wastewater (clear water) is drawn out of the SBR stage. It is pumped out by an air lift (or mammoth) pump, which uses compressed air. The air lift pump is designed not to pump out any floating sludge on top of the clear water layer. A minimum water level is maintained in the system without any further components.

In multi-tank systems, there is also a phase in which the sludge is returned to the system.

Once step 3 is complete, the cleaning process starts again with step 1.

Two cycles are undertaken a day. The maintenance company can individually adapt the switching times.

Holiday mode

The operator can switch the plant to holiday mode when he is planning to be away for an extended period. In this event, water is no longer discharged from the plant. Aeration is minimal to maintain the aerated sludge. In case of multi-tank systems, a small amount of wastewater is recirculated within the system via the sludge lifter in order to mix younger and older activated sludge ("recirculation").

Underload detection

Alternatively, the plant can be time-controlled to operate depending on its filled level. For this purpose, the controller is fitted as standard with a pressure sensor that can be activated by a specialist on request. This pressure sensor should be activated on new plants only after they have been run in reliably.

This pressure sensor tests the level in the first chamber every 12 hours, or at the nominal start of each cycle. When there is little or no inflow or the level is low, no treatment cycle is initiated. Instead, there is minimum aeration to maintain the aerated sludge. The controller then displays "Cycle pause". Once the level measured in the first chamber exceeds a certain limit, a normal treatment cycle is initiated.

In the case of multi-tank systems, a small amount of wastewater is recirculated within the system via the sludge lifter in order to mix younger and older activated sludge ("recirculation").

When fitted with underload detection, the plant can run independently of the actual hydraulic load, helping to cut operating costs. This mode proves above all practicable when the inlet fluctuates greatly over the course of the week, e.g. when the residents are not regularly at home. Underload detection must be configured by a specialist.

3.2.3.2 Plants with extra nitrogen elimination (discharge class N and D)

The wastewater treatment plant applies the biological processes of nitrification and denitrification to remove nitrogen content. Plants designed for extra nitrification generate a particularly intensive aeration that provides the optimal living conditions for nitrifying bacteria, which convert the ammonium content of wastewater into nitrate. Plants designed in addition for extra denitrification generate brief aeration pulses that recirculate the water at the suitable time. This serves to stimulate the denitrifying bacteria responsible for converting the nitrate into elementary nitrogen, which discharges as a gas out of the plant.

All GRAF treatment systems can be used for nitrification and denitrification. No additional componentry is needed. Solely the controller's cleaning program must be configured accordingly.

3.2.3.3 Plants with extra phosphate elimination (discharge class D+P, P module)

Phosphates are precipitated out by means of polyaluminium chloride dosed to the SBR reactor. The phosphate precipitation equipment includes a removable support platform in the tank dome (accessory, art. no. 107362). The precipitant canister is located on this platform. Alternatively, the precipitant canister can be positioned separately near the switch cabinet. There is a dosing pump in the plant's switch cabinet. This dosing pump conveys the precipitant out of the precipitant canister and into the SBR reactor. The precipitant is supplied to the reactor during the feed phase. The amount of precipitant needed can be set on the metering pump. Mixing takes place during the aeration phase. The precipitant forms an insoluble compound with the phosphate, which settles in the tank.

3.2.3.4 Plants with extra hygiene (discharge class D+H)

The additional UV module can also be fitted to remove germs from the biologically cleaned water. This disinfection takes place with ultraviolet (UV) light. This kills microorganisms within a matter of seconds, leaving no residue or harmful by-products.

3.2.3.5 Plants with additional carbon dosing (C module)

Carbon can be dosed to the aeration stage to offset any nutrient deficiency. This may become necessary during extreme underload phases or when the wastewater exhibits a suboptimal quality.

In this event, a dosing pump in the switch cabinet conveys automatically a specific quantity of special nutrient solution directly into the aeration basin. This dose can be adjusted at the controller. Carbon dosing serves to maintain the stability of the aerated sludge quantity in the system, even when there is only a sporadic or very low supply of wastewater.

3.3 Control and machine cabinet

All the plant's mechanical and electrical components are installed in a switch cabinet. The cabinet for internal installation is made of expanded polypropylene (PP; used for wastewater treatment plants for 5–25 PE) or powder-coated metal (used for wastewater treatment plants for 30 PE or more).

The internal PP switch cabinet can be fitted in a GRAF external switch cabinet, and in this manner used out of doors as well.

For wastewater treatment plants larger than 30 PE there are also external switch cabinets available, in which the control and machine technology can be installed.

		
<p>Internal PP switch cabinet (no more than 25 PE)</p>	<p>Steel cabinet for indoor installation</p>	<p>External switch cabinet for internal PP switch cabinet</p>
		
<p>External plastic switch cabinet (30–50 PE)</p>	<p>XL metal external cabinet (60–160 PE)</p>	<p>XXL metal external cabinet (165–250 PE)</p>

Figure 4 – Available switch cabinets

3.3.1 Technical setup

The main components of the controller are:

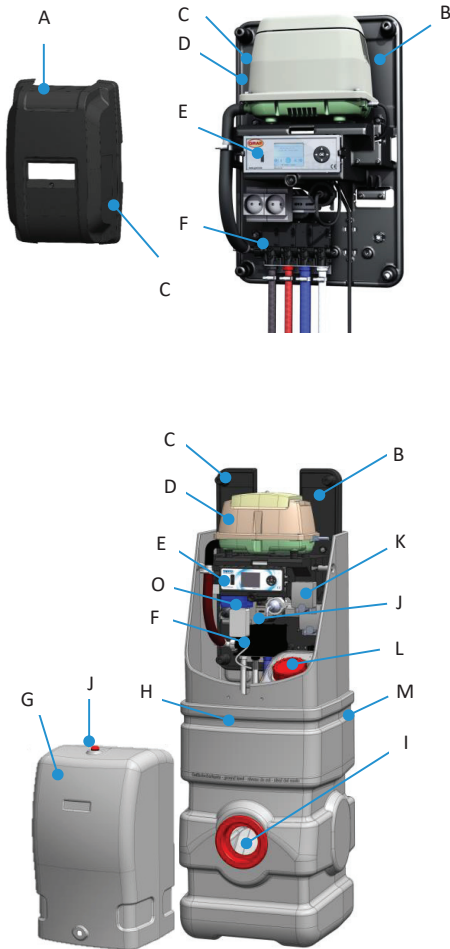

Figure 5 – Example layout of an external switch cabinet for internal PP switch cabinet

A	Internal cabinet hood
B	Bearer
C	Type plate
D	Compressor
E	Control unit
F	Air distributor
G	External cabinet hood
H	External cabinet base section
I	Empty pipe aperture for external cabinet
J	Power strip 230 V
K	Dosing pump (optional)
L	Chemicals tank 37 l (optional)
M	Chemicals tank vent (optional)
N	Warning light
O	Communication module (optional)
P	Empty pipe seal (accessories)
Q	Air hoses (accessories)



Figure 6 – Accessories

3.3.2 Siting

The control unit must not be fitted or activated in environments with potential explosive atmospheres or in places where there are flammable materials. Sparks in such environments may cause an explosion or fire and this may result in physical injuries or even death.

Ensure that the machine cabinet is not installed above or in the direct vicinity of water vessels. Risk of electric shock if improperly installed.

The switch cabinet must be freely accessible at all times for maintenance work. The ventilation apertures in the switch cabinet must remain unobstructed at all times and may not be covered.

- PP control cabinet: Ventilation apertures on the bottom and top
- Internal control cabinet: Ventilation apertures on the sides
- External control cabinet: Ventilation apertures on the rear

Switch cabinets for indoor installation

Switch cabinets for indoor installation must be sited in a dry, well ventilated room, e.g. basement or garage.

Switch cabinets for outdoor installation

Switch cabinets for outdoor installation should be sited, whenever possible, away from direct sunlight which would otherwise cause overheating in the summer.

3.3.3 Power supply



WARNING

Hazardous voltage

- Danger from electric shock. An electric shock can cause serious burns and life threatening injury.
 - Only specialised electricians may be assigned to work on the electrical installations and to connect the plant to its power supply.
-

The machine cabinet may be connected only to a correctly installed 230 V socket or earth cable fitted with an upstream 16 A fuse. Additional electrical fixtures on the same fuse may disrupt operation.

The power supply to the switch cabinet must be ensured at all times. If the plant is disconnected from the mains for more than 24 hours, it will be unable to clean the wastewater properly, if at all.

Electrical equipment connected to the mains may be damaged during a storm. We would recommend fitting surge protection in the building to protect against this. The connection cable must be laid such that it does not represent a tripping hazard.

4 The wastewater treatment system's control unit

The one2clean plus wastewater treatment plant is fitted as standard with two controllers depending on its size and equipment:

- **KLcontrol.S**
- **KLcontrol.M**

The plant is controlled at the operating unit on the controller's face side. The controller is used to configure the operating parameters, view the operating statuses, query the plant parameters, and program the operating times (this last by a specialist).

The controller presents two access levels with basic and advanced functions and parameters:

- **User menu for the operator** (not password protected)
- **Service menu for specialists** (password protected)

4.1 Operating the controller

Use the small wastewater treatment plant only when it is in perfect working condition, only for its intended purpose, and only with all due diligence to safety and risks as set down in the full Technical Documentation. The housing enclosing the controller for wastewater treatment plants may not be opened. Please refer any questions to the manufacturer.



IMPORTANT

Keep the plant switched ON at all times!

- If the plant is disconnected from the mains for more than 24 hours, it will be unable to clean the wastewater properly, if at all.
- Switch OFF the plant for maintenance and repair purposes only.
- Immediately after this work, switch the plant back ON.

4 The wastewater treatment system's control unit

4.1.1 Operating unit

The operating unit consists of a USB port (A), a display (B), a cursor pad (C), and a status LED (D).

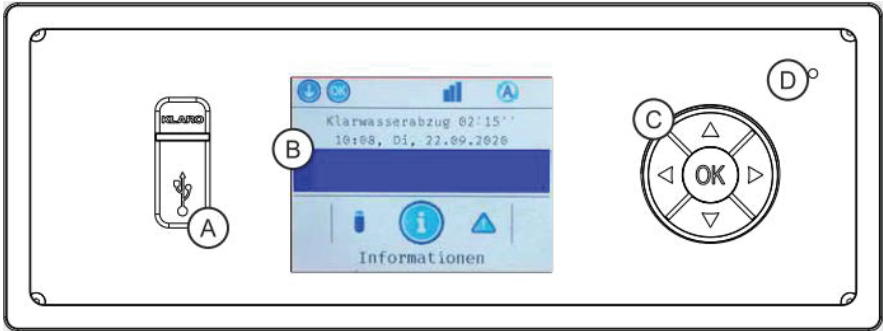

Figure 7 – KLcontrol.S operating unit

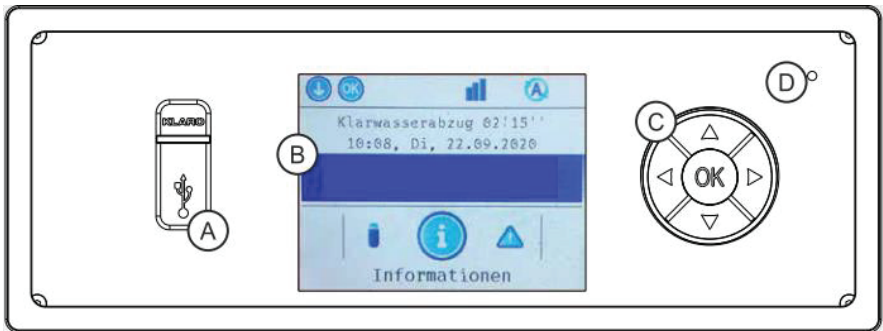

Figure 8 – KLcontrol.M operating unit

USB port (A)

The USB port accepts a USB stick (see also Subsection 9.7 on page 63).

Display (B)

Menu navigation is presented on a colour display. The backlight switches OFF after 60 seconds of user inactivity and back ON when the cursor pad (C) is pressed.

Cursor pad (C)

The cursor pad is used to navigate through the menus and enter parameters. The cursor pad offers five input options:

- [OK] (centre)
- ◀ cursor left
- ▶ cursor right
- ▲ cursor up
- ▼ cursor down

Status LED (D)

This LED indicates the present status as one of the four following colours:

- green: auto mode, everything OK
- blue: manual mode
- yellow: warning; continued operation possible
- red: fault, intervention necessary; no operations possible

4.2 Display information and menu navigation













Figure 9 – KLcontrol graphic display

1. Actions now possible (menu navigation at cursor pad)
2. Status bar (see Subsection 4.2.1 Status bar symbols)
3. Current step of the wastewater treatment plant
4. Remaining runtime of the current step
5. Clock and date
6. Event bar (fault, malfunction, info) sorted according to relevance (see Subsection 10.2 on page 74).
7. Menu selection (see Subsection 4.2.2 Menu bar symbols)

4 The wastewater treatment system's control unit







4.2.1 Status bar symbols

The controller status appears in the status bar. The displayed symbols also serve as navigation aids through the menu structure. The following symbols are provided:

Symbol	Description
	Auto mode: The controller is in auto mode.
	Manual mode: Auto mode has been suspended.
	Pressure sensor 1 (without boundary): Pressure sensor has been detected and calibrated to factory default.
	Pressure sensor 1 (with boundary): Pressure sensor has been detected, calibrated on service level, and activated.
	Pressure sensor 2 (without boundary): Pressure sensor has been detected and calibrated to factory default.
	Pressure sensor 2 (with boundary): Pressure sensor has been detected, calibrated on service level, and activated.
	Service level: The service menu has been enabled.
	USB stick: A USB memory has been inserted and detected.
	Wireless module: A wireless module has been connected to KLcontrol. There is no signal.
	Wireless module: A wireless module has been connected to KLcontrol. The link to the remote display is active.
	Communication module: The communication module's link to the WebMonitor has been detected. On detected activity, either the transmit or receive arrow flashes.

4 The wastewater treatment system's control unit

4.2.2 Menu bar symbols

Symbol	Description
	Information: This presents e.g. total operating hours, controller settings, and sensor measurements.
	Events: This presents information, malfunctions, and errors with time stamps. The max number of messages is 125.
	Mode: Manual mode can be activated here.
	Times/date: This is used to set dates, the clock, and holiday periods.
	Settings: Here the user can choose from 25 languages and enter or edit buzzer and display settings.
	Service: This is the access area for specialists.
	USB: This is used to update the software, save/load configurations, and save logging data.

4.3 User menu

4.3.1 Information menu – show operating hours, settings, sensor values

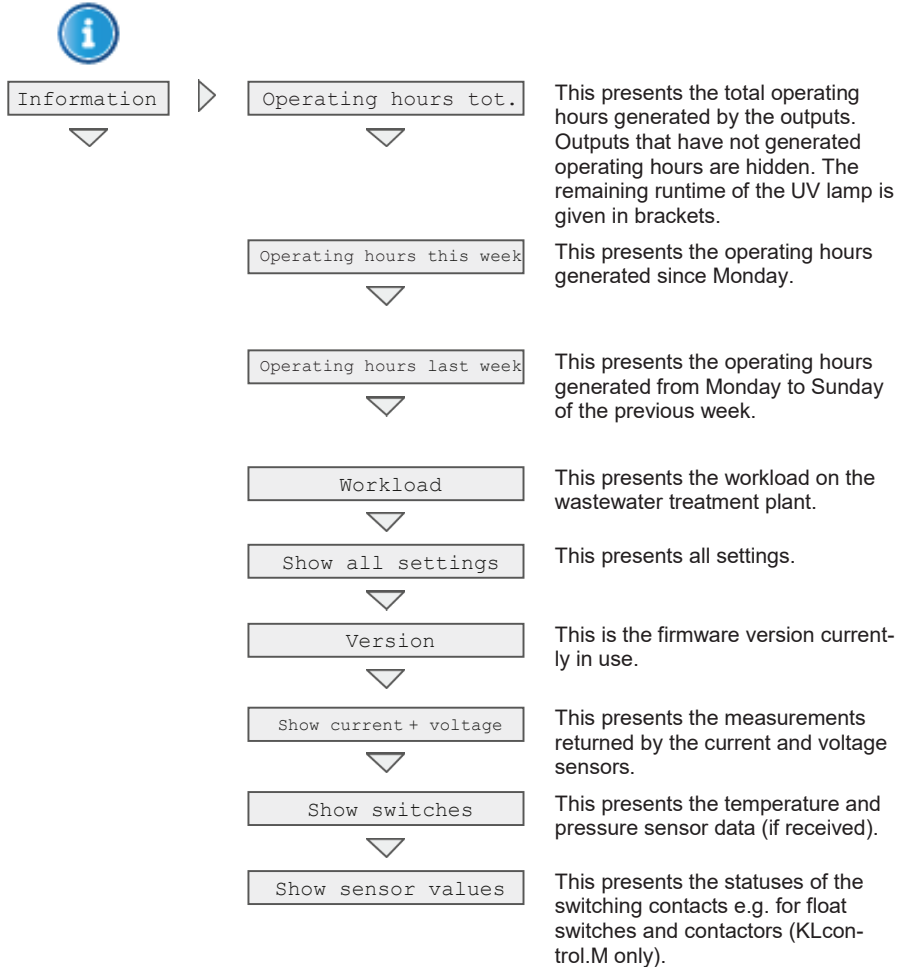

Query operating hours

1. Using the cursor keys [◀] [▶], select the menu ⓘ “Information”.
2. Press [OK] twice to open the menu “Operating hours tot.”.
 - The total operating hours for each consumer now appear:

Operating hours total	[h]
Valve 1	X.XX
Valve 2	X.XX
Valve 3	X.XX
Valve 4	X.XX
Compressor 1	X.XX
...	X.XX

Displaying settings



1. Using the cursor keys [◀] [▶], select the menu ⓘ “Information”.
3. Press [OK] to open the menu ⓘ “Information”.
4. Using the cursor keys [▼] [▲], select the menu “Show all settings”.
5. Press [OK] to open the menu “Show all settings”.
 - All information on the controller settings now appear:

Show all settings	
Cycle settings	
Pressure sensor information	
Temperature sensor	KLcontrol.M only
Current limits	
Maintenance	
Modules	

4.3.2 Events menu – show events

			
Events	▶	<div style="border: 1px solid gray; padding: 5px; margin-bottom: 5px;"> <F.xx> <date> <clock> (error message) </div> <div style="text-align: center;">▼</div> <div style="border: 1px solid gray; padding: 5px; margin-bottom: 5px;"> <S.xx> <date> <clock> (fault message) </div> <div style="text-align: center;">▼</div> <div style="border: 1px solid gray; padding: 5px;"> <H.xx> <date> <clock> (information message) </div>	<p>“Show events” can present up to 125 occurred events. The latest event is always placed at the top of the list.</p>

Read out events

1. Using the cursor keys [**◀**] [**▶**], select the menu  “Events”.
2. Press [**OK**] to open the menu  “Events”.
 - All events are now listed in chronological order, with the latest at the top:

Event	Date	Clock
F/S/H.X	dd/mm/yy	hh:mm:ss
...		

A new event committed to a full memory overwrites the oldest. The events shown are prefixed with <abbreviation> <date> <clock>. The abbreviations are as follows:

- “H” – information
- “S” – fault
- “F” – error

Pressing [**OK**] shows additional information on the selected event, e.g. the event type (information / fault / error), the full event name, and its date and clock time.

4 The wastewater treatment system's control unit

4.3.3 Mode menu – switching to manual mode

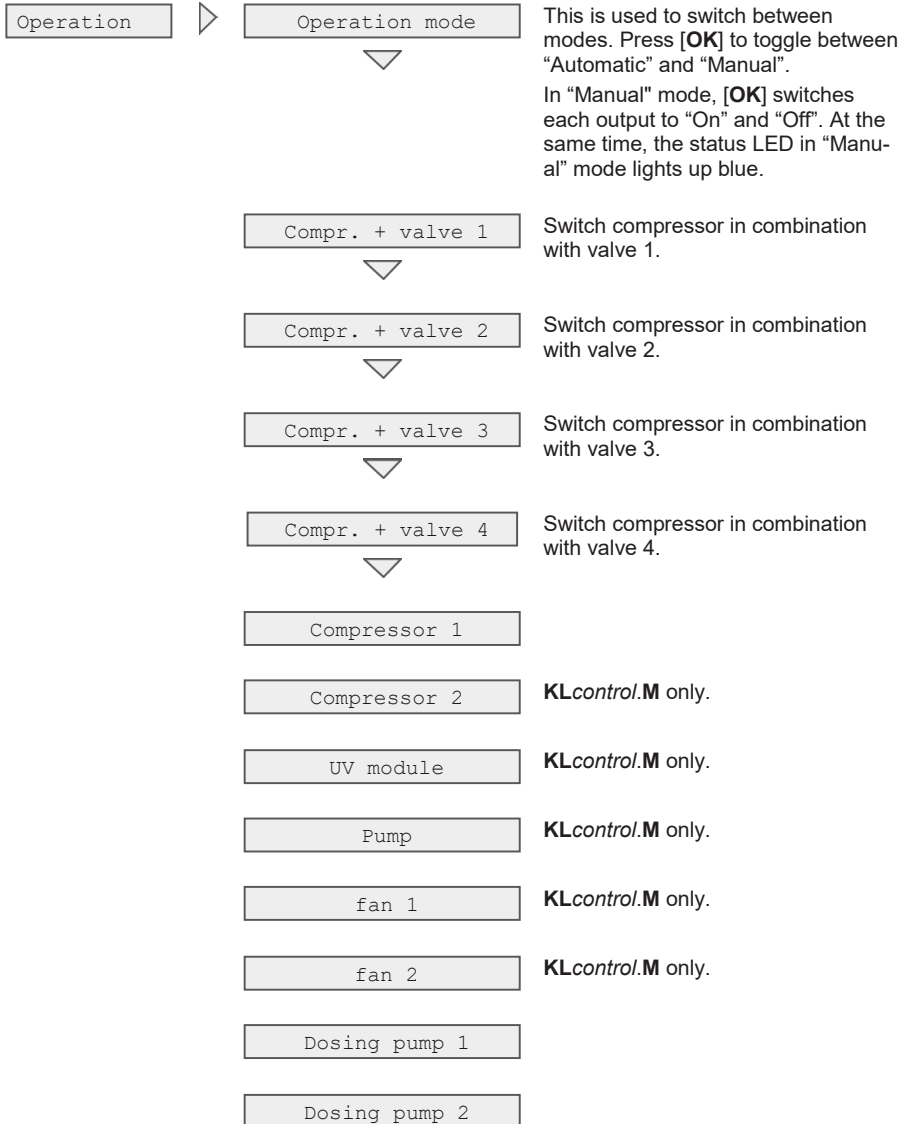



4 The wastewater treatment system's control unit

Dosing pump 3	KLcontrol.M only.
Warning lamp	
fan 3	KLcontrol.M only.
Output 24 V	
Valve 1	
Valve 2	
Valve 3	
Valve 4	
Level measuring	

Level measuring is initiated manually when all conditions like default calibration, service calibration, and the limit have been set (see also *Subsection 9.1 Underload detection on page 55*).

Activate consumers manually

1. Using the cursor keys [**◀**] [**▶**], select the menu  "Mode".
2. Press [**OK**] twice to activate "manual" mode .
 - When manual mode is active,  appears in the symbol bar and the status LED lights up blue.
3. Each of the consumers can now be selected with the cursor keys [**▼**] [**▲**].
 - Only those consumers are visible that have been activated in the controller.
4. To switch ON or OFF the selected consumer, press [**OK**].
5. To revert to auto mode, select this mode with the cursor keys [**▼**] [**▲**] and confirm with [**OK**].

Each consumer should run for at least 5 seconds when testing because it takes some time to monitor the power consumption of valves before any faults are detected.

4 The wastewater treatment system's control unit

4.3.4 Times/date menu – set date, clock, holiday period

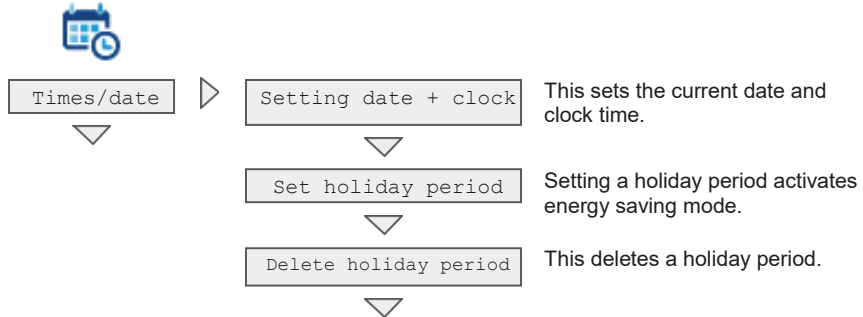

Set date and clock

1. Using the cursor keys [**◀**] [**▶**], select the menu  "Times/date".
2. Press [**OK**] twice to open the menu "Set date + clock".

Setting date + clock
XX/XX/XXXX
dd/mm/yyyy
XX:XX:XX
hh:mm:ss

3. Use the cursor keys [**▼**] [**▲**] to set the date and clock time, and confirm with [**OK**].
→ Your settings are saved only when you confirm them with [**OK**]!

Set holiday period

1. Using the cursor keys [**◀**] [**▶**], select the menu  "Times/date".
2. Press [**OK**] to open the menu "Set date + clock".
3. Using the cursor keys [**▼**] [**▲**], select the menu "Set holiday period".
4. Press [**OK**] to open the menu "Set holiday period".

Setting date + clock
Start: dd/mm/yyyy
End: dd/mm/yyyy

5. Use the cursor keys [**▼**] [**▲**] to set the start and end dates, and confirm with [**OK**].
→ Your settings are saved only when you confirm them with [**OK**]!

4 The wastewater treatment system's control unit

4.3.5 Settings menu – languages, buzzer, display settings

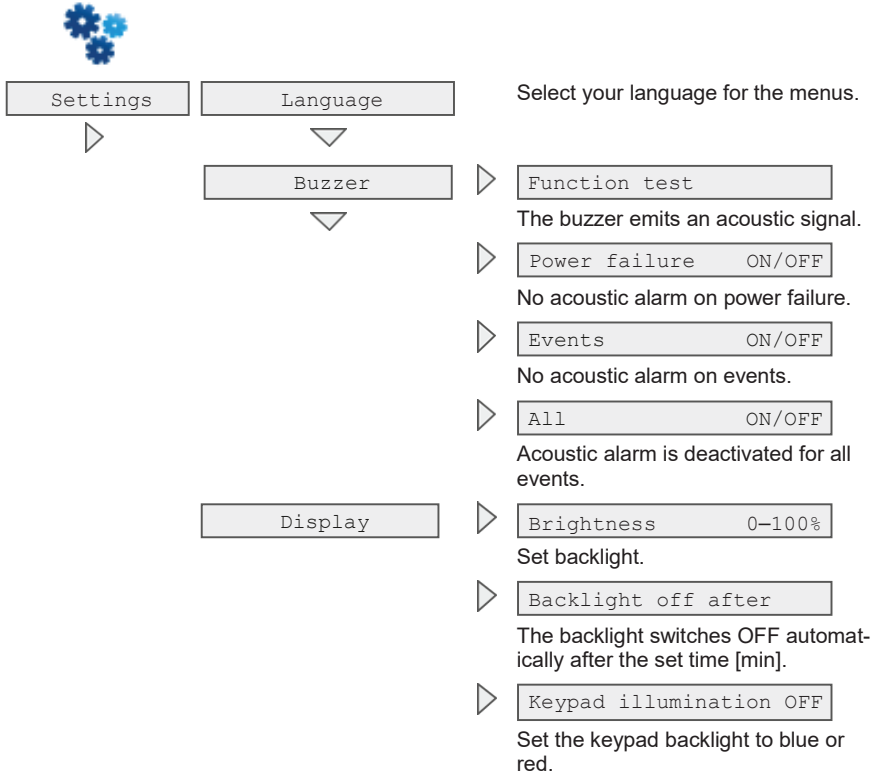

Select languages

- Using the cursor keys [**◀**] [**▶**], select the menu  "Settings".
- Press [**OK**] twice to open the menu "Language".
- Use the cursor keys [**▼**] [**▲**] to select your language, and confirm with [**OK**].
→ You can now choose from 25 languages.

1 German	8 Finnish	15 Portuguese	22 Czech
2 English	9 Danish	16 Bulgarian	23 Hungarian
3 French	10 Estonian	17 Croatian	24 Turkish
4 Spanish	11 Latvian	18 Polish	25 Russian
5 Italian	12 Lithuanian	19 Romanian	
6 Norwegian	13 Greek	20 Slovak	
7 Swedish	14 Dutch	21 Slovenian	

4 The wastewater treatment system's control unit

4.3.6 Service menu – access for specialists



Service



Enter code: <XXXX>

Code protected access for
specialists.



IMPORTANT

Unqualified changes to these settings may prove detrimental to the plant's correct and reliable operations.

4 The wastewater treatment system's control unit

4.3.7 USB menu – software update, maintenance manual

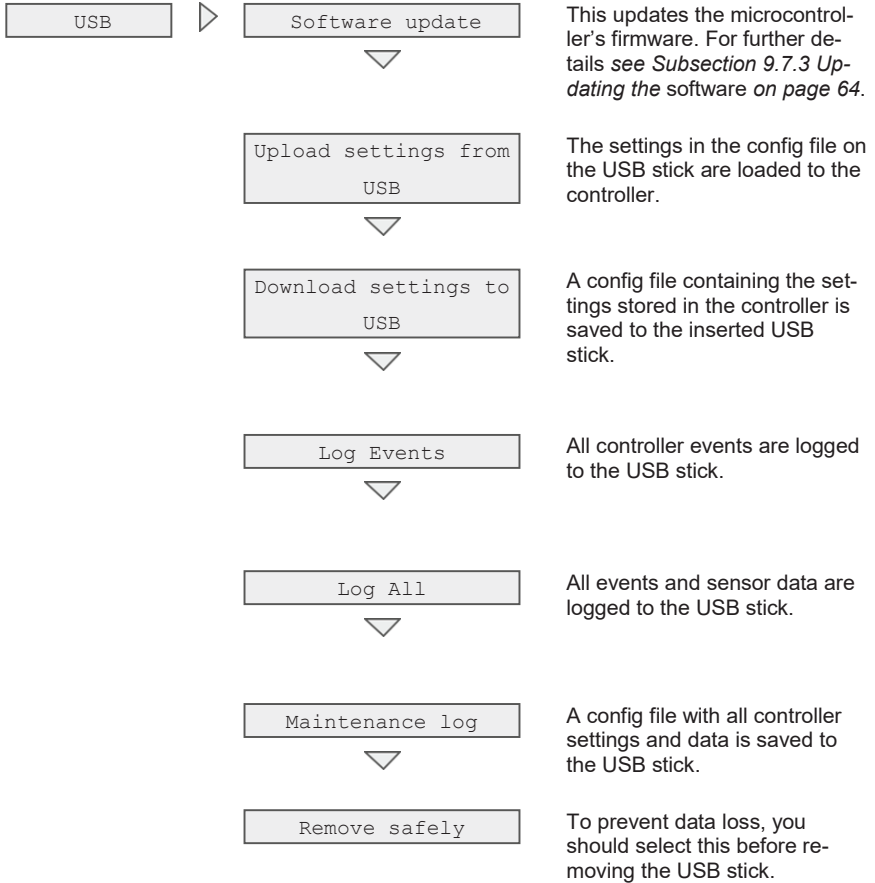

4.4 Function of the power cut detector

The control unit is equipped with a power cut detector, which is powered via an integrated emergency power supply (buffer). Upon delivery, the emergency power supply is flat, but re-charges after the controller has been switched ON. In the event of a power cut, the charge of one emergency power supply for power cut signals will last around 12 hours. If the emergency power supply is not required in response to power cuts, it is prevented from discharging by a switching circuit.



IMPORTANT

If the plant is disconnected from the mains for more than 24 hours, it will be unable to clean the wastewater properly, if at all.

In the event of mains failure, the time / date setting is powered for around 10 days by an extra buffer. All saved data, such as operating hours and program settings, are retained. If the time and date are not set, weekly operating hours for the units are no longer saved. Error messages occurring in the future are saved with the wrong date

4.5 Monitoring the mains voltage

The controller detects failed and excessive mains voltage. It detects an incorrect mains voltage by measuring the input voltage and comparing this with defined limits. The limits defined for an incorrect input voltage are $< 90 \text{ Veff}$ and $> 250 \text{ Veff}$ respectively.

Brief outages (e.g. during thunderstorms) are ignored within a certain time delay. After this time, the controller disconnects from its power supply.

• Action – immediately on incorrect mains voltage:

- All relevant data are saved to nonvolatile memory
- All outputs and the backlight are switched OFF as a measure to protect these and to avoid unnecessary draws on the buffer battery.
- The error is entered in the log book.
- If the mains voltage returns to its defined range within 5 seconds, the controller resumes the active cycle. A message is entered in the log book.

• Action – incorrect mains voltage after 5 seconds:

- An intermittent beeping is heard, and the LED flashes red in sync. This beeping can be deactivated in the menu "Settings" → "Buzzer" → "Power failure". In this event, only the LED flashes red.
- The external warning lamp (if fitted) is not activated.

4 The wastewater treatment system's control unit

Once the mains voltage returns to its defined range, the controller is rebooted.

If power has failed for less than 90 minutes, auto mode resumes where it left off. If the power failure equals or exceeds 90 minutes, the clarified water is discharged and then the sludge returned. Afterwards, the controller switches to auto mode.

4.6 Hardware reset

If the controller no longer responds, its hardware must be reset.

- To reset the hardware, press and keep pressed **[OK]** for 5 seconds.
 - The controller powers down and reboots.
 - When the hardware is reset in auto mode, the program resumes where it left off.

The hardware can also be reset in the menu  "Service" (code 1311).

5 Initial use

The wastewater treatment plant may be put into operation only when all of its components have been installed and connected to the full extent. Before commissioning, confirm that all electrical connections and air hoses have been fitted correctly and firmly!

5.1 Commissioning log

Commissioning must be documented in the log provided for this purpose. One (carbon) copy each of this log must be handed over to the operator, the approving authority, and the installer.

5.2 Charging the tanks

- Before switching ON the plant, fill the tank(s) to the top with fresh water.

5.3 Switching ON the switch cabinet

- Switch cabinets with main switch: Set the main switch to the position »1«.
- Switch cabinets without main switch: Insert the mains power plug into a socket.

The treatment cycles have been preconfigured to factory defaults and can be edited only by a service specialist. During commissioning, "Cycle pause" and its remaining time appear on the display. After this remaining time, the first clarification cycle is initiated.

5.4 Function tests

- Activate "manual" mode.
 - In manual mode, tests can be performed on the lifters, aeration, and other connected consumers.
 - The ventilation bubbles must be consistent and thorough.
 - The air lift pumps operate only when the tank is sufficiently filled with water.

For further details on these function tests, see *Subsection 4.3 on page 22*.

5.5 Startup behaviour

In general, GRAF wastewater treatment plants require only a short startup phase. The startup phase is the time needed until the biotope generated in the wastewater treatment plant has become adequate to deliver and maintain the required discharge values.

The bacteria are carried in the wastewater into the treatment plant. The plant may also be "inoculated" with aerated sludge taken from another treatment system, but normally this is unnecessary.

5 Initial use

The startup phase depends on many factors, including e.g. the wastewater quantity and quality, the water temperature, the intended treatment, etc.

If the intended treatment is based solely on carbon removal (discharge class C), the results are obtained after only a few days. Higher requirements (discharge class N, D) can extend this period to a number of weeks until adequate aerated sludge has formed. Specifically, the bacteria responsible for nitrification grow more slowly.

Usually, the startup phase is shorter in summer than winter because the bacteria multiply more readily at higher temperatures.

The startup phase may generate foaming. This characteristic bacterial foaming has a dull, beige-brownish colour. This foam can pile up on the surface of the water, but cannot impair operations.

6 Operating instructions

The plant must remain switched ON at all times. The sole exception is during maintenance. If the plant is switched OFF for more than 24 hours, it will be unable to clean the wastewater properly, if at all.

Basically, only substances with the characteristics of domestic wastewater may enter the plant. Biocides, toxic substances or substances which are not biocompatible or biodegradable must not, under any circumstances, enter the plant: these will otherwise cause biological process problems. The following are not permitted:

- rainwater from roofs and yards
- infiltration water (e.g. drainage water)
- liquid or solid residue from animal husbandry
- commercial or agricultural wastewater, unless it is comparable to domestic wastewater
- chemicals, pharmaceuticals, mineral oils, solvents
- cooling water
- solids in the form of food waste, plastics and hygiene articles, coffee filters, bottle tops and other domestic items
- milk and milk products
- water discharged from swimming pools
- large volumes of blood
- large quantities of grease or vegetable oils

If larger volumes of grease or plant-based oils are discharged, we would recommend pre-cleaning the wastewater containing the greases/oils with a grease separator upstream of the wastewater treatment plant.

(IMPORTANT: Faeces must not be allowed to enter the grease separator!) The wastewater from commercial kitchens must be pretreated separately in an upstream grease separator. GRAF offers grease separators with nominal sizes up to 15.

General recommendations for cleaning agents:

- Note the recommended doses on the packaging.
- Heed all warnings on the packaging, e.g. "Harmful to aquatic life".
- In most cases, cleaning agents in powder form are more eco-friendly than liquids.
- Whenever possible, refrain from using tabs, pods, and toilet fresheners.
- The general rule – "The dose makes the poison" or "It's the quantity that matters"!

The table below contains a list of substances which must not be disposed of in the wastewater treatment plant:

6 Operating instructions

substances which should not be disposed of via the sink or toilet:	Why not:	Where then:
Ash	Does not break down	Dustbin
Chemicals	Contaminate the wastewater	Collection points
Disinfectants	Kill bacteria	Do not use
Paints	Contaminate the wastewater	Local collection point
Photochemicals	Contaminate the wastewater	Local collection point
Chip fat	Is deposited in pipes and causes blockages	Dustbin
Adhesive plaster	Blocks the pipes	Dustbin
Cat litter	Blocks the pipes	Dustbin
Cigarette butts	Are deposited in the plant	Dustbin
Condoms	Blockages	Dustbin
Corks	Are deposited in the plant	Dustbin
Varnishes	Contaminate the wastewater	Local collection point
Medicines	Contaminate the wastewater	Collection points, pharmacies
Engine oil	Contaminate the wastewater	Collection points, service stations
Waste containing oil	Contaminate the wastewater	Collection points, service stations
Plant protection agents	Contaminate the wastewater	Local collection point
Paintbrush cleaners	Contaminate the wastewater	Local collection point
Cleaning agents, except chlorine-free products (environmentally sound)	Contaminate the wastewater, corrode piping and seals	Local collection point
Razor blades	Risk of injury to staff in the sewage system and treatment plant	Dustbin
Pipe cleaners	Corrode piping and seals, contaminate the wastewater	Local collection point
Pesticides	Contaminate the wastewater	Local collection point
Panty liners	Cause blockages, non-degradable plastic films blight watercourses	Dustbin
Cooking oil	Cause deposits and pipe blockages	Local collection points
Food waste	Cause blockages, attract rats	Dustbin

6 Operating instructions

substances which should not be disposed of via the sink or toilet:	Why not:	Where then:
Wallpaper paste	Causes blockages	Local collection point
Textiles (e.g. nylon tights, cleaning cloths, handkerchiefs etc.)	Block pipes, may paralyse a pump station	Used textiles collection point
Thinner	Contaminates the wastewater	Local collection point
Bird sand, cat litter	Cause deposits and pipe blockages	Dustbin
Cotton buds	Block the plant	Dustbin
Toilet blocks	Contaminate the wastewater	Do not use
Nappies	Block the pipes	Dustbin
Cement water	Is deposited, results in production of concrete	Contact specialist company

7 Operation and maintenance

Almost all operating problems will result in the plant's cleaning capacity being impaired. This must be detected in good time and remedied immediately by the operator or a maintenance specialist.

Before commencing work

- Prior to all inspection and maintenance work, familiarise yourself with the safety instructions in *Subsection 2*.
- Read and follow the instructions given in the following.



WARNING

Danger of tripping and falling at open tank covers

- There is a danger of persons or animals falling into the tank. This may result in harm to health, serious injury, or drowning.
- Secure open tank covers with suitable measures, and never leave them unattended.
- Keep unassigned persons, in particular children, away from open tank covers.



WARNING

Danger of poisoning and asphyxiation from harmful gases

- Wastewater treatment plants can pose risks to health and life in the form of poisonous, harmful, and asphyxiating gases.
 - Whenever possible, avoid working inside the tank.
 - When entering the tank, do not fail to observe *Safety measures for work inside the tank in Subsection 2.4.1*.
 - Never enter the tank without a second, supervising person at the entrance.
-

7.1 General specifications for maintenance, inspections, and operation

The plant must remain switched ON at all times. The sole exception is during maintenance. If the plant is switched OFF for more than 24 hours, it will be unable to clean the wastewater properly, if at all.

- Switch OFF the plant for maintenance and repair purposes only, and switch it back ON immediately after this work!
- Before all work on the mechanical, electrical, and pneumatic/hydraulic components, first set the main switch to the position »0« or disconnect the controller's mains plug.

7.2 Duties of the operator

The operator of a wastewater treatment system is obliged to safeguard its reliable operation and to maintain an operating log book.

This operating log book must list e.g.

- measured values
- deviations from nominal values
- malfunctions

The water authorities may ask to see this log. Reliable operation requires the operator to conduct the regular inspections listed in the following.

7.2.1 Daily check

- Check that the plant is operating properly.
 - The illuminated inspection LED is green, and there is no acoustic warning:
The plant is operating properly.
 - The illuminated inspection LED is yellow or red:
The plant is malfunctioning. Immediately remedy the malfunction, or notify your maintenance partner.

7.2.2 Monthly checks

- Visually check for any sludge leaks, clouding, or discoloration in the discharge
- Visual check for clogged supply and discharge routes
- Read operating hours counter for air compressor (total operating hours), aeration (valve 1), clear water extraction (valve 2) and sludge return (only in systems with multiple tanks) (valve 3) and if necessary any other units and note in operating log.
- Check the control cabinet's air filter

7 Operation and maintenance

- Check and, if necessary, clean or replace the filter for venting the control cabinet (ventilation grille on left and right in housing wall of internal cabinet or on rear of external cabinet).
- To clean or replace the grille, first remove it from the cabinet's outside. Apply a little pressure with a screwdriver to release the clip fastener, and remove the grille by hand. The filter mat is not secured in the ventilation shaft and can be shaken and/or blown out. The time at which the air compressor filter is to be cleaned or replaced depends on the extent of contamination caused by the atmospheric conditions of the application. Follow the service documents provided by the compressor manufacturer to check or replace the filter on the compressor.
- Check the UV module (if fitted).
 - See the operating instructions for the UV module
- Check the P module (if fitted).
 - Check that the dosing pump is operating properly.
 - Check the level in the precipitant container.
- Check the Infiltration (if fitted).
 - Implement preventive measures immediately you detect any signs of failure, e.g. wet surfaces or wastewater backflow in the infeed section.
 - Remove regularly any buildup in the distributor units and open infiltration areas.

7.2.3 Yearly checks

- Determine the consumption of mains water, and enter this in the operating log book.

7.3 Care and maintenance by a maintenance specialist only

A specialist must be commissioned to service the plant at least every six months. This is reduced to at least every four months on plants with discharge classes +P and +H. To this end, the plant owner should take out a maintenance contract with a qualified specialist. A maintenance contract may also be stipulated by law.

7.3.1 Maintenance work

- Inspect the operating log book for correct operation (nominal/actual comparison)
- Check the filter of the compressor and the supply/exhaust air openings on the control cabinet
- Air compressor maintenance according to details provided by manufacturer (see Annexes)
- Check that all essential, mechanical, and electrical installations are operating properly, e.g. aerator, lifts, control unit, valves, alarm equipment, and battery in power cut detector
- Carry out general cleaning work, e.g. to remove deposits
- Check the structural condition of the plant
- Check sufficient aeration and ventilation
- Analysis of the aeration basin:
 - Oxygen concentration ($O_2/l > 2 \text{ mg}$); if necessary, adjust compressor operating times
 - Sludge volume $SV_{30} (< 700 \text{ ml/l})$; if $> 700 \text{ ml/l}$, sludge removal is required
 - Check that there is an even aeration pattern (bubbling)
- Sampling from discharge and analysis of the following values:
 - temperature of wastewater
 - substances that can settle
 - pH
 - odour
 - colour
 - depth of visibility
 - BOD5 (every other maintenance)
 - COD value
 - NH_4-N (if required)
 - nanorg (if required)
 - P (if required)

The maintenance work undertaken, any damage found, repairs undertaken and other information should be summarised in a maintenance report by the maintenance company. A suitable

template is provided in the Annex. Anything established during the analyses should also be documented in this report. The plant operator should be given the maintenance report so that it can be passed to the responsible authorities if demanded. The maintenance report should be attached to the operating manual. Please keep the operating log in a place where it can be easily accessed.

Plant failures resulting from insufficient maintenance (e.g. of the compressor) will not be covered by free replacement under warranty.

7.4 Sludge measurement

In the one2clean plus system only activated sludge is found. Sludge removal is recommended if the sludge volume is **over 70%**.



The sludge measurement is carried out by determining the sludge volume in a measuring cylinder (SV30 test). When measuring, proceed as follows:

Preparation:

The aeration in the tank must be active or switched on in manual mode. As soon as the aeration tank is sufficiently mixed, an activated sludge sample can be taken with the help of a sampler.

The measuring cylinder should be set up vibration-free and protected from direct sunlight. Since one2clean plus systems are usually operated with higher sludge contents, a double determination is necessary:

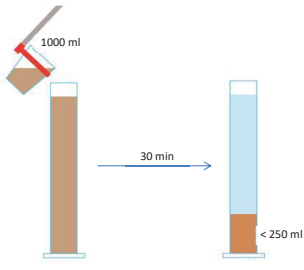
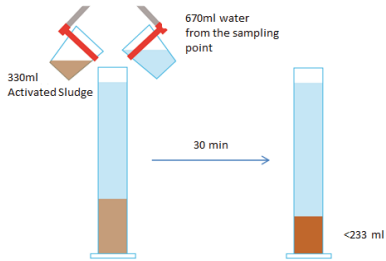
7 Operation and maintenance

Double determination with 2 measuring cylinders: 1x undiluted, 1x diluted	
	
<p>Fill the measuring cylinder with the sludge sample up to the 1000 ml mark</p>	<p>Only fill in 330 ml of the measuring cylinder with the sludge sample, then fill up to the 1000ml mark with discharged water from the sampling point</p>
<p>Read the result after 30 minutes and round it to 10 ml/l</p>	
<p><250 ml/l : Make a note of the value</p> <p>>250 ml/l : Discard the measurement, Use the diluted version</p>	<p><250 ml/l : Multiply value by 3 Save the result</p> <p>>250 ml/l : Save the result as „>750 ml/l“</p>
<p>Measures: <250 ml/l : none / in order</p>	<p>Measures: <700 ml/l : none / in order >700 ml/l : Initiate sludge removal Increase aeration</p>
<p>Example:</p>	
<p>Result of undiluted measurement: 750 ml/l → discard</p>	<p>Result of diluted measurement: 190 ml/l → $190 * 3 = 570$ → Result: 570 ml/l</p>
	

Sludge must be removed by a specialist only

Over the course of time, sludge starts accumulating in the wastewater treatment plant. On reaching certain limits, this sludge must be removed. When sludge must be removed is decided during maintenance.

Basically:

- Sludge is removed when necessary.
- Sludge must be removed by a specialist following the pertinent, applicable regulations.
- The sludge removal must be confirmed, and this confirmation handed over to the operator.
- Failure to remove sludge promptly will pose an additional stress on the biotope. Adequate cleaning performance is then no longer ensured.
- Needs-based sludge removal is determined by the sludge levels measured during maintenance. Sludge must be removed in compliance with the local provisions.

When the sludge is being removed:

- 10 cm of water /sludge mixture should remain in the system so that there is enough biology for the biological cleaning process. Make sure that the built-in-parts are not damaged (membrane aerator!).
- In the case of systems with multiple tanks, the sludge removal in the first tank is sufficient. This is because the individual chambers / tanks are connected to one another.
- After emptying or desludging of the system, it must immediately be filled with fresh water against the flow direction.

Procedure:

1. Switch on the aeration in manual mode and let it mix briefly
2. Insert the suction hose into the desludging pipe until it reaches the floor
3. Aspirate until a wastewater level of about 10 cm remains in the tank.

Then the wastewater treatment plant has to be refilled with fresh water.

8 Service menu for authorised specialist

Configuring the parameters in the Service menu requires specific knowhow.



NOTE

The Service menu is intended for specialists only and is code protected.

- Do not attempt to edit any of the settings here. This may otherwise prove detrimental to the plant's correct and reliable operation.

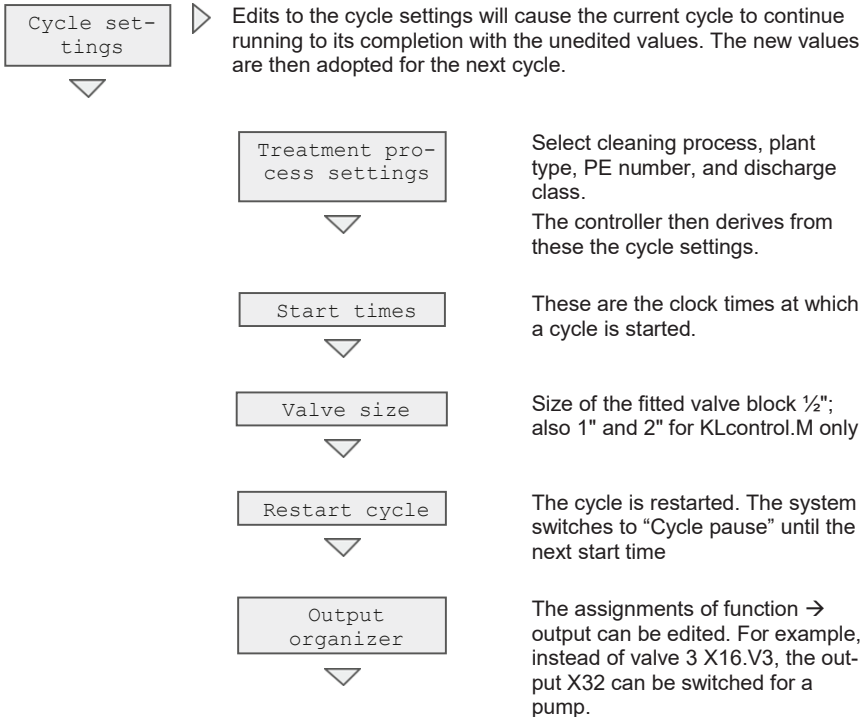

8 Service menu for authorised specialist

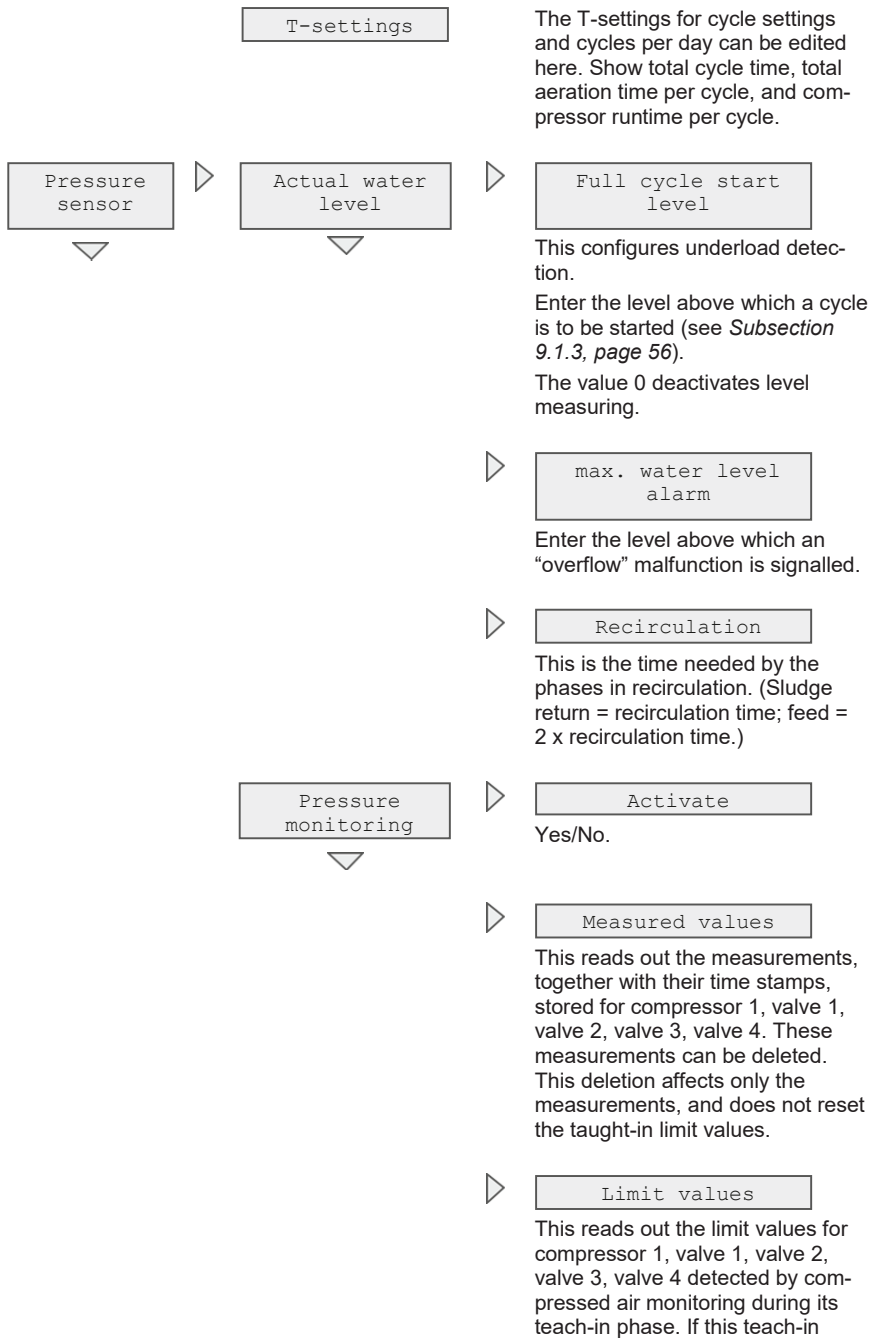

8 Service menu for authorised specialist

phase is still active, the limit values are 0.



Reset

This resets compressed air monitoring to its original state. The teach-in phase begins anew.

Calibration
with diffuser



An automated calibration sequence is initiated on the pressure sensor for calculating levels as a function of the measurements returned by the membrane pipe diffusers. Please follow the instructions on the display.

Calibration
with airlift

An automated calibration sequence is initiated on the pressure sensor for calculating levels as a function of the measurements above which the lifter is started. Please follow the instructions on the display.

Information



Delete wkl.
operating
hours



This resets the weekly operating hours.

Delete all
operating
hours



This resets the total operating hours with the exception of the UV module.

The operating hours counter increments from 0.00 to 99999.99 hours. Exceeding the maximum limit causes the counter to begin again from 0.

Show wkl. oper-
ating hours



This presents for each output the weekly operating hours for the last 53 weeks.

Outputs that have not yet generated operating hours are hidden.

Delete all
events

All entries in the log book are deleted.

8 Service menu for authorised specialist

Temperature
(KLcontrol.M only)



Temp. 1:
fan on



Cooling fan is switched ON.

Temp. 2:
warning



In addition, a fault message is entered in the log book.

Temp. 3:
compressor off

Plant stop; an error occurs.

Current
limits



Max. current
limit



This sets the upper limit value for the outputs above which an error is detected. Monitored outputs: Valves 1 to 4, compressors 1 and 2, UV module, cooling fans 1 and 2, pump, dosing pumps 1 to 3, warning lamp, cooling fan 3, reserve 24 V.

Min. current
limit

This is the lower limit value for the outputs' current monitoring under which an error is detected. Monitored outputs as for max. current limit.

INFO Setting both limit values to 0 deactivates current monitoring for this output.

Service



Set service
date



Enter here the date for the next maintenance. A blank input field shows "dd/mm/yyyy". The setting 0 deactivates service at intervals. An expired service date outputs a message to the display (service alarm).

Set service
interval



This sets the service interval from 0 to 12 months. After the set interval, a maintenance prompt message is output to the display (service alarm). The following date is always calculated automatically on the basis of the internal calendar.

show next serv.
date interv.



If the maintenance date at intervals is activated, this presents the automatically calculated date of the next service interval. If no interval

8 Service menu for authorised specialist

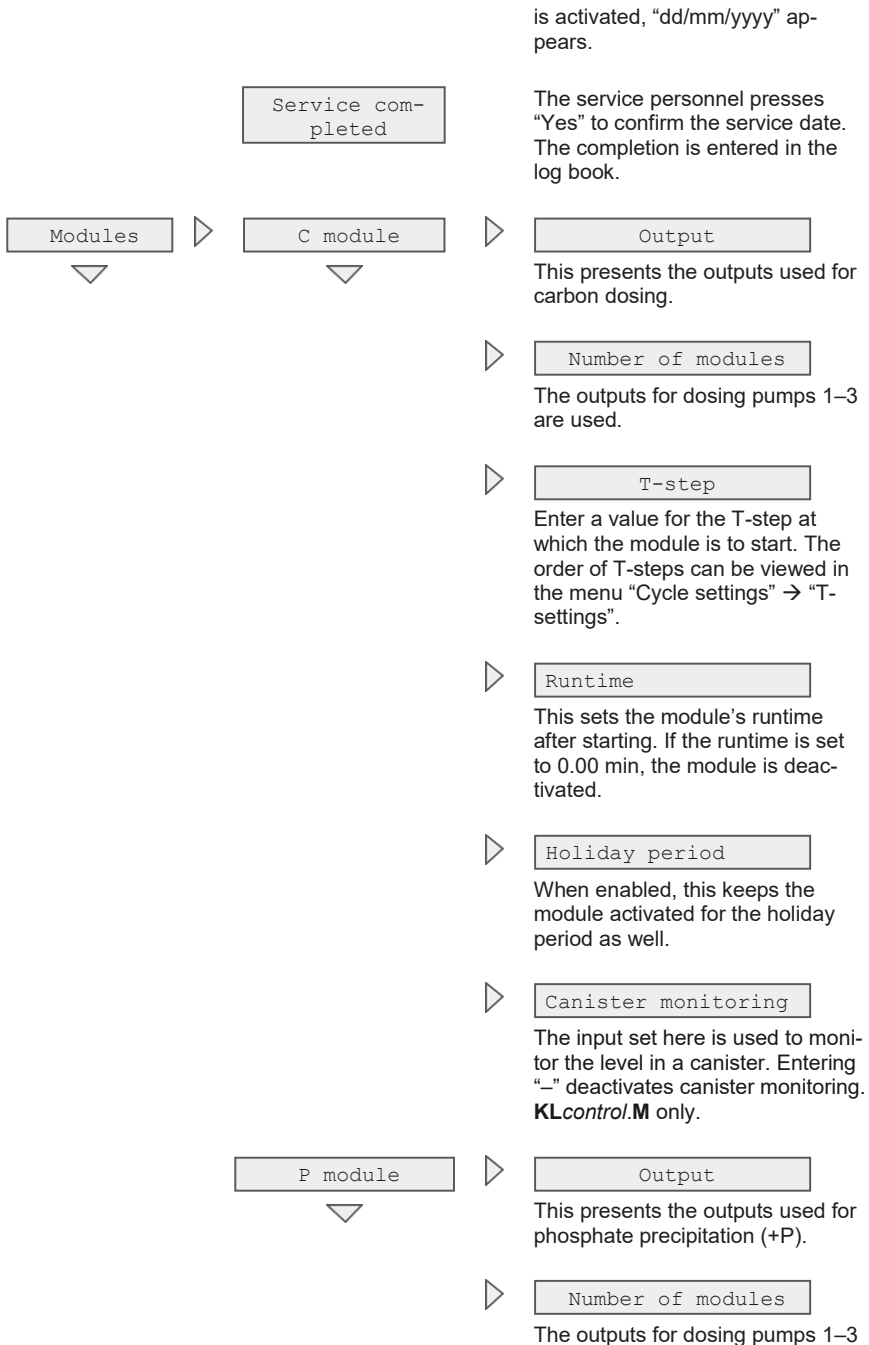

8 Service menu for authorised specialist

Chlorination
module
(KLcontrol.M only)



are used.



T-step

Enter a value for the T-step at which the module is to start. The order of T-steps can be viewed in the menu "Cycle settings" → "T-settings".



Runtime

This sets the module's runtime after starting. If the runtime is set to 0.00 min, the module is deactivated.



Canister monitoring

The input set here is used to monitor the level in a canister. Entering "-" deactivates canister monitoring. **KLcontrol.M** only.



Output

This presents the outputs used for chlorination.



Number of modules

The outputs for dosing pumps 1–3 are used



T-step

Enter a value for the T-step at which the module is to start. The order of T-steps can be viewed in the menu "Cycle settings" → "T-settings".



Runtime

This sets the module's runtime after starting. If the runtime is set to 0.00 min, the module is deactivated.



Input

The input used for the water switch to activate the chlorination module.

8 Service menu for authorised specialist

▷
The input set here is used to monitor the level in a canister. Entering “-” deactivates canister monitoring.

(KLcontrol.M only)

▷
This presents the outputs used for the UV module.

▷
The outputs for the UV lamp and reserve 230 V are used.

▷
Enter a value for the T-step at which the module is to start. The order of T-steps can be viewed in the menu “Cycle settings” → “T-settings”.

▷
This sets the module’s runtime after starting. If the runtime is set to 0, the module is deactivated.

▷
The input used for a float switch to activate the UV module.

▷
This is the number of operating hours generated by the UV radiator above which a message appears.

▷
This resets the operating hours generated by the UV radiator

(KLcontrol.M only)

▷
▽

This sets the output function to be monitored. This output is no longer current-monitored.



▷

This is the input used, always X20.1.

8 Service menu for authorised specialist

Close
menu

Code activation has ended.

8.1.1 Select table

1. Using the cursor keys [◀] [▶], select the menu "Service".
2. Press [OK] to open the menu "Service".
3. Use the cursor keys [▼] [▲] to enter the four-digit service code, and confirm with [OK].
 - The Service menu opens
4. Press [OK] to open the menu "Cycle settings".
 - The menu "Cycle settings" opens.
5. Press [OK] to open the menu "Treatment process settings".
 - The menu "Treatment process settings" opens.

Treatment process settings	
Process	X
System	X
PE number	X
Discharge class	X

6. Using the cursor keys [▼] [▲], select the menu you want, and highlight this with [OK].
7. Using the cursor keys [▼] [▲], select the setting you want, and confirm with [OK].

8 Service menu for authorised specialist

8.1.2 Overview of processes, systems, and discharge classes

There are a total of 7 cleaning processes with up to 4 discharge classes each to choose from.

	1	2	3	4	5	6	7
Process	SBR 4V	SBR MAX 4V	SBR MAX 3V	SBR One 3V	SBR One 2V	Flow 2V	Flow 1V
System	KLARO	KLARO MAX	KLARO MAX	KLARO One	KLARO One	Logo	Moving bed
	Klaro Easy	-	container	KLARO One+	easyOne	Fixed bed	Fixed bed
	EPro	-	-	easyOne	one2clean +	Fluidised bed	Fluidised bed
	Graf prof	-	-	one2clean+	one2clean	-	-
	-	-	-	one2clean	EClean	-	-
	Demo	Demo	Demo	Demo	Demo	Demo	Demo
Discharge class	C/N/D/D+	C/N/D	C/N/D	C/N/D	C/N/D	C/N	C/N

These instructions describe exclusively one2clean plus (SBR ONE) systems with 2 valves (2V) for one tank systems and 3 valves (3V) for multi-tanks systems. So select these.

Table layouts

The table is divided into work steps, e.g. feed, and runtime calculations. Also the number of cleaning cycles per day can be edited.

All work steps are made up of 3 T-steps. The first T-step of a work step is the total duration of the work step. The two following T-steps specify the activation and deactivation periods within this work step.

Example work step for aeration: T7 = 240 min is the total duration of aeration. Within these 240 minutes, aeration alternates between ON for 6 min (T8) and OFF for 4 min (T9).

8 Service menu for authorised specialist

Functions	Example values for 5 PE SBR 2V Discharge class C
Feed	X31,
T 1 Σ	0,00 min
T 2 ON	0,00 min
T 3 OFF	0,00 min
Denitrification	X31, X16.V1
T 4 Σ	0,00 min
T 5 OFF	0,00 min
T 6 ON	0,00 min
Aeration	X31, X16.V1
T 7 Σ	480,00 min
T 8 ON	10,00 min
T 9 OFF	10,00 min
Sedimentation	X31, -
T 10 Σ	120,00 min
T 11 ON	0,00 min
T 12 OFF	120,00 min
Clear water extraction	X31, X16.V2
T 13 Σ	9,36 min
T 14 ON	9,36 min
T 15 OFF	0,00 min
Sludge return	X31, -
T 16 Σ	0,00 min
T 17 ON	0,00 min
T 18 OFF	0,00 min
Cycle pause	X31, X16.V1
T 19 OFF	30,00 min
T 20 ON	4,00 min
Holiday	X31, X16.V1
T 21 ON	4,00 min
T 22 OFF	30,00 min
Cycle time	609,36 min
Aeration time	8,00 h/d
Compressor runtime	8,31 h/d
Cycles per day	2 1/d

Table 1 – Layout of cycle tables

9 Additional controller functions

9.1 Underload detection

Underload detection is deactivated by default. When the plant is started up, it runs in automatic mode regardless of the volume of wastewater flowing in. **We recommend activating this function after a run-in phase of 3 months at the earliest!**

The KLcontrol.S control unit is fitted with a pressure sensor as standard and this can be used to establish the level in the first chamber. This function is used to save energy when the flow of wastewater is low.



IMPORTANT

Incorrect settings will cause malfunction

- Incorrect calibration of the plant could cause it to operate constantly in economy mode (with cycle pause). Correct cleaning of wastewater is not then possible.
- Level-dependent operation must be activated by a maintenance fitter or expert only.

9.1.1 Function

The water level is measured via the pressure in the air diffusor at the start of a cleaning cycle. The measurements follow an adjustable measuring interval. If the water level in the tank exceeds a previously set level ("level measuring" in the service level), the system starts a cleaning cycle. If the set level is not reached, the system automatically pauses for the set interval. In this case, only enough oxygen is pumped into the system so that the biology is preserved. During the cycle break, the water level continues to be measured at the set intervals. If, after a certain period of time, sufficient wastewater has flowed into the system and the set level has been reached, the control switches to the normal cleaning cycle.

The number of cleaning cycles undertaken can be queried using the "Operating hours" menu item. This indicates the cleaning cycles actually undertaken with the cycles performed in automatic mode (2 a day) as a ratio and as a percentage (25% to 100% utilisation).

9.1.2 Calibrating level measuring

Calibrating adjusts the offset for the level's characteristic curve. This involves adjusting the measurements to the backpressure of the pipe aerator. Level measuring always uses the pressure sensor 1.

Calibration can be accessed in the Service menu under "Pressure sensor" or following the entry of the password "8888" for the Service menu.

9 Additional controller functions

Before or during the calibration, the water level in the primary treatment must be measured from the bottom of the tank.

Service calibration functions

The controller guides the user through the calibration and displays the remaining time and the current pressure. The controller performs 3 measurements. Afterwards, the measured water level must be entered (in cm).

In the event of an implausible input, the value can be reentered or the calibration aborted. If the entry corresponds to the calculated value, the calibration can be saved. The displayed offset results from the pressure resistance of the aeration system.

Plausibility check – measurements with the pipe diffusers

Offset c [cm] = calculated level d [cm] - measured level b [cm] (see Figure 10)

If the calculated offset is less than 0, the result is implausible. The measured level must always be smaller than the calculated level because the compressor has to overcome the resistance of the pipe diffuser and therefore, the pressure is higher.

9.1.3 Starting level measuring

The tank(s) must be filled with water up to the height at which a cleaning cycle starts. This level depends on the geometry of the tank and the number of connected inhabitants (PE).

The recommended buffer heights a (see Figure 10) above the minimum water level are specified for the various configurations in the table below.

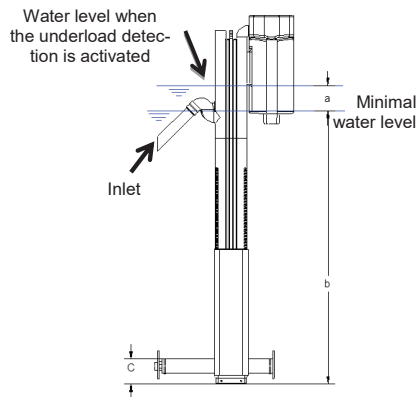

Figure 10– Level measurement via membrane tube aerator

9 Additional controller functions

Recommended maximum buffer heights in sludge reservoir / buffer:

	Carat				Carat XL	
Type	2.700	3.750	4.800	6.500	8.500	10.000
H [cm]	100	115	130	155	160	175

Step 1: Calibrate pressure sensor

It is absolutely essential that the sensor is calibrated for starting up underload detection. Please carefully work through the following points in order:

Service Enter code: * * * *	Open the menu  "Service", press [OK], and, when prompted, enter for the calibration the following code: 8 8 8 8
Calibrate ◀ No Yes ▶	Using the cursor keys [◀] [▶], select "Calibrate Yes", and confirm with [OK] to start calibration.
Measurement un- derway	3 measurement processes are undertaken automatically.
000 cm Current level	Enter the current level you have measured with a dipstick in the tank (measured from the tank base to the surface of the water), and confirm with [OK].
Save ◀ No Yes ▶ Offset XX cm	This offset indicates the resistance of the aeration system during calibration. Using the cursor keys [◀] [▶], select "Save Yes" to end calibration.

Step 2: Set controller parameters

It is absolutely essential that the controller parameters for level measuring are set for the plant to function correctly. Please carefully work through the following points in order:

Service Enter code: * * * *	Open the menu  "Service", press [OK], and, when prompted, enter the general service code.
Pressure sensor Level measuring	Using the cursor key [▼], select "Pressure sensor", and confirm with [OK]. In the menu "Pressure sensor" now appearing, press [OK] to open "Level measuring".

9 Additional controller functions

Cycle start level 000 cm	<p>Press [OK] to open the menu “Cycle start level”. Using the cursor keys [▲] [▼], enter the water level <i>b</i> above which a treatment cycle is to be started (see table above). Confirm your entry with [OK].</p>
Overflow warning 000 cm	<p>NOTE It is not essential for the overflow warning message to be activated for the plant to function correctly. If 000 cm is saved, this warning message remains deactivated.</p> <p>To activate, measure the height between the base of the tank and bottom edge of the emergency overflow in the discharge. Confirm your entry with [OK].</p> <p>→ Saving the value 000 cm deactivates the overflow warning message.</p>
Recirculation 120 sec	<p>Press [OK] to open the menu “Recirculation”. Using the cursor keys [▲] [▼], enter the value 120 sec, and confirm this with [OK]. The necessary settings are now complete. Press [◀] to exit the menu. This function is only possible for systems with sludge recirculation.</p>

Step 3: Function check

Level measuring can now be undertaken in manual mode for checking purposes. This requires level measuring to be activated with **[OK]**. The control unit automatically takes a measurement. Once the process is complete, the measured value appears.

9.1.4 Deactivating the level measurement

To deactivate level measuring and again run the cycles dependent on time, proceed as described under “Step 2: Set controller parameters in Subsection 9.1.3, and enter 0 cm for the water level *b*. The set recirculation can remain at 120 seconds.

9.1.5 Safety and fault messages

If the sensor measures a value below 40 cm, the following message appears on the display: “Fault: Min. level”. If this happens, the plant reverts to the normal time-controlled mode. This is either triggered by too low a water level (≤ 40 cm) in the measuring chamber or a leak in the pressure or measurement line. In this event, we recommend contacting your maintenance company.

If the sensor measures a value greater than “Warning overflow”, this message appears on the display. If this happens, the plant reverts to the normal time-controlled mode. The cause is either too high a wastewater supply or a clogged clear water lifter. In this event, we recommend contacting the maintenance company.

9.2 Compressed air monitoring

General: Compressed air monitoring is activated in the Service menu. If compressed air monitoring is activated for the KLcontrol.S controller, this accesses automatically pressure sensor 1. This means that no level measurements are possible. KLcontrol.M controllers or later access automatically pressure sensor 2.

Settings: Compressed air monitoring is decoupled from the actual cycle process. Monitored are compressor 1, valve 1, valve 2, valve 3, and valve 4. Compressed air monitoring switches to one of two states: teach-in phase and monitoring phase:

Teach-in phase: In the teach-in phase, each monitored output returns the pressure values based on the set parameters. At the end of the teach-in phase, these are used to derive a minimum and a maximum limit value. If the menu does not present a minimum and maximum value, the controller is still in the teach-in phase.

Monitoring phase: Pressures are measured on the basis of the set parameters. These are compared with the calculated minimum and maximum values with consideration to the set tolerance. If a measured value exceeds this tolerance, a fault is generated and entered in the log book.

9.3 Phosphate precipitation with dosing pump (P module)

A dosing pump can be connected to the controller, either to terminal X12.1 (KLcontrol.M) or X12.7 (KLcontrol.S).



CAUTION

Substances harmful to health

- The precipitants iron (III) chloride and polyaluminium chloride are harmful to health. There is a danger of severe irritation to skin and eyes. Ingestion can be harmful to health.
 - Wear goggles, protective gloves, and protective clothing.
 - Consult the safety data sheet provided by the manufacturer.
-

Before the precipitant device can be started, the precipitant container must first be placed in a frost-proof location (e.g. in the machine cabinet or the plant's dome shaft). The pressure and intake hoses must also be laid in frost-free areas. The pressure hose is to be routed into the SBR reactor and placed inside the reactor with the outlet located above the reactor basin, ensuring that the precipitant flows directly into the wastewater to be treated and does not dampen any components (aggressive chemicals entail a risk of damage to components!). The outlet must never be submerged in the water!

9 Additional controller functions

- Insert intake hose into precipitant tank until you are sure it is drawing precipitant from the base.
- Connect suction and pressure hoses to pump's hose connectors and lock with union nuts.

In the menu  "Operation", activate the dosing pump set for phosphate precipitation, and confirm that the precipitant is being drawn correctly. If necessary, swap the hose connections.

When using the dosing pumps (DP) for more than one purpose, note the following:

- 1 module → DP2
- 2 modules → DP2, DP3
- 3 modules → DP2, DP3, DP1

The output functions (DP) must be assigned to the outputs in the menu "Cycle settings" → "Assign outputs". Any superimpositions of the outputs between the modules are not intercepted.

Settings:

- Output: This presents the physical outputs operated by the P module.
- Modules (1–3): Depending on the settings, the outputs used are for the dosing pumps 1, 2, 3.
- T-step (T1–T28): This is the T-step with which the module is to be started
- Runtime (0–99 min): A setting > 0 activates the module. The module is started with the set T-step and runs for the duration of the entered runtime.
- Canister monitoring (-, X12.9, X12.11, X20.1, X20.2): This activates canister monitoring. A triggered input causes the fault message "P-canister empty" to appear. Entering "—" deactivates this function. There is no canister monitoring provided for the KLcontrol.S controller.

PE	P	ml/min	[min]
4	2	5.5	2
6			3
8			4
12			6
16	5	19.0	8
20			3
25			4
30			5
35			5
40			6
50			8



Figure 11 – Compact dosing pump

PE	ml/min	[min]
4	4.4	4
6		5
8		7
12		11
16		15
20		18
25		23
30		27
35		32
40		36
50		45

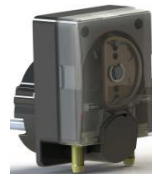



Figure 12 – Dosing pump DP24 (DSP1501)

9.4 Pumped carbon dosing (C module)

The C module operates analogously to the P module, but comes with the additional setting “Holiday period”.

When a value is entered under  “Times/date” → “Set holiday period”, the C module automatically detects underload and no longer steers carbon dosing as a function of the set T-step, but at each cycle start time. However, a value must first have been entered for “Holiday period” in the C module.

When using the dosing pumps (DP) for more than one purpose, note the following:

- 1 module → DP1
- 2 modules → DP1, DP2
- 3 modules → DP1, DP2, DP3

The output functions (DP) must be assigned to the outputs in the menu “Cycle settings” → “Assign outputs”. Any superimpositions of the outputs between the modules are not intercepted.

9.5 Pumped chlorination (chlorination module)



CAUTION

Substances harmful to health

- The liquid chlorine compound (sodium hydrochloride) is harmful to health. There is a danger of severe irritation to eyes and the respiratory tract. Ingestion can be harmful to health.
- Wear goggles, protective gloves, and protective clothing.
- Consult the safety data sheet provided by the manufacturer.

The chlorination module operates analogously to the P module, but comes with a setting for an input (X12.9, X12.11, X20.1, X20.2). There is no chlorination provided for the KLcontrol.S.

When using the dosing pumps (DP) for more than one purpose, note the following:

- 1 module → DP1
- 2 modules → DP1, DP2
- 3 modules → DP1, DP2, DP3

The output functions (DP) must be assigned to the outputs in the menu “Cycle settings” → “Assign outputs”. Any superimpositions of the outputs between the modules are not intercepted.

Function:

Variant 1

Chlorination starts and ends with the discharge of clear water (the affected T-step must be set for this) when only the runtime has been set to greater than 0.

Variant 2

Setting an input. Chlorination starts and ends with the discharge of clear water, but does not start until the float switch fulfils its requirements. There is also a plausibility check on the float switch. (The float switch can be active only when clear water discharge is active.)

Variant 3

Chlorination starts and ends with a discharge of clear water, via the clear water pump, analogously to Variant 2.

9.6 UV reactor (UV module)



WARNING

Danger to health from UV radiation

- UV radiation is harmful to skin and eyes.
 - Wear UV goggles and clothing impermeable to light.
 - Consult the operating instructions provided by the manufacturer.
-

Always disconnect the UV disinfectant device from its power supply before:

- performing any repairs
- cleaning the plant
- replacing the UV radiator

9.6.1 Starting up the UV module

The UV module can be activated by means of an entered runtime or an entered input. Setting this runtime to "0 min" and the input to "-" deactivates the module. A runtime > 0 min starts the module with the set T-step (T1–Tx). If only the input has been set, the module's output is switched at the same time as this input.

If values have been entered for both settings, the module's output is switched only when the input is active within the runtime (started with the set T-step).

Activating the UV module switches over T14 ON/T15 OFF → T15 OFF/ON T14. This means that the pre-glow time is switched ahead of the clear water discharge. One example of setting the UV module during clear water discharge:

Clear water discharge X31, X16.V2

T13 Σ	5.00	min
T14 OFF	2.00	min
T15 ON	3.00	min

- The ON and OFF times are switched over automatically after the UV module has been activated

9 Additional controller functions

- The OFF time (T14) now defines the pre-glow time. Here, "T15 OFF" = 2 minutes.
- The total time (T13) must be increased by the pre-glow time. Here, "T13 Σ" = 5 minutes.
- The "T-step" for the UV module in the menu  "Service" → "Modules" → "UV module" is set to T14.
- The setting "Runtime" for the UV module is set to 5 minutes. It should be equal to the total time (T13).

If an input has been set in addition to the pre-flow time, the UV module is switched OFF automatically after the pre-glow time when no signal is detected from this input.

Further setting options in the Service menu:

- Output: This presents the physical outputs operated by the UV module
- Modules (1–2): Depending on the settings, the outputs used are for the UV lamp and reserve 230 V.
- Max operating hours (1500 h): The UV lamp's maximum number of operating hours is entered here. Exceeding this runtime outputs a corresponding message to the display.
- Reset: The UV lamp's runtime can be reset when it is replaced with a new one.

9.7 Using the USB port / software updates

The KLcontrol controller for wastewater treatment plants features on its face side a USB port that can take a USB memory stick. This lets you

- update software,
- save/load a configuration,
- save logging data,
- save the maintenance manual

IMPORTANT

Moisture and dirt may enter the device through an unprotected USB port. For this reason, make sure that after using the face-side USB port it is sealed properly with the rubber cover. Check this rubber cover regularly, and replace immediately when damaged.

9.7.1 USB stick requirements:

- The USB stick must be formatted for the FAT32 file system. NTFS is not supported.
- Write protect must be disabled.
- Do not partition the memory.

9.7.2 Removing the USB stick safely

To prevent data loss, make sure before removing the memory that data are no longer being written to or read from it.

Execute the menu function "Remove safely" before withdrawing the USB stick.

9.7.3 Updating the software

The firmware may be updated only as instructed by the manufacturer (see the provided RE-ADME file).

Before updating the microcontroller's firmware, you will first need a USB memory stick containing the manufacturer's original file.

Back up your data before updating. To do so, save the current configuration and the log book to a USB stick.



IMPORTANT

Incorrectly updated firmware can damage the controller.

- The power supply to the controller may not be disconnected during the update.
 - Do not remove the USB stick during the update.
 - Wear UV goggles and clothing impermeable to light.
 - Consult the operating instructions provided by the manufacturer.
-

The update is complete when the controller reboots. During the update, the screen is OFF.

9.7.4 Saving/loading a configuration

A config file containing the controller's settings can be saved to a USB stick or loaded into the controller from the same. Data saved to the stick generates the new file "config.txt". If the receiving stick already contains a file of this name, this will be overwritten by the data from the controller.

9.7.5 Logging

All sensor values are saved every 5 minutes. The User menu provides a function to copy these logging data as a CSV file to a USB stick.

There are two logging options:

- **Log All:** All data from sensors, including pressure and temperature sensors, and all voltages and current measurements, T-steps, remaining times, and occurred events are logged to the USB memory at five-minute intervals.
- **Log Events:** Only all occurred events are written to the logging file.

The file name of this log is log.txt. If the USB stick already contains a file with this name, then the names of all successive log files are incremented accordingly as log1.txt, log2.txt, etc.

The log file is made up of a header (date, version number, microcontroller serial number, controller serial number) and the current log data (log event type, time stamp, text).

9.7.6 Maintenance manual

All controller contents like operating hours, settings, etc., are saved to a USB stick. The name of the file generated contains the controller's serial number for easier assignment.

The maintenance manual can be downloaded from Webservice (GRAF Webmonitor). If interested, please contact your maintenance company.

9.8 Cooling fan control (KLcontrol.M only)

The cooling fans are steered by means of temperature sensors.

The temperature measured is compared with the set temperature thresholds (accuracy ± 5 °C). Above temperature threshold 1, the fans are activated. Above temperature threshold 3, only the fans are activated. All other outputs are switched OFF.

9.9 External warning indicator

A warning lamp can be connected to one of the 24 V outputs. The output X12.5 has been configured as the factory default for the warning lamp. The output for the warning lamp is configured in the menu  "Service", under "Cycle settings" > "Assign outputs". The warning lamp is activated at the same time as the buzzer. The warning lamp and the buzzer are switched OFF when the fault message has been acknowledged in the menu.

9.9.1 Contactor monitoring (KLcontrol.M only)

Compressors with a high current draw are steered via a contactor.

The output function needing to be monitored can be set in the menu  "Service". Contactor monitoring is deactivated when no output function has been selected.

Activating contactor monitoring deactivates automatically the current monitor for this output, irrespectively of the current measuring limits set in the Service menu.

Monitoring activated for KLcontrol.M uses automatically the input X20.1.

The contactor is monitored with a defined debouncing time. Also contactors activated with 24 V can be used.

9.10 Current monitoring

The outputs are monitored on the basis of total current measurements. 24 V and 230 V outputs are measured separately and can be checked for their break or short circuit state.

The editable current minimum and maximum for output monitoring have been set to default values in the Service menu. A break is detected when the measured value is less than the mini-

9 Additional controller functions

imum. A short circuit is detected when the maximum value is exceeded. Setting both limit values to 0 deactivates current measuring for this output.

An output is assigned definitively only when this is the only one (24 V or 230 V) active during measurements. If more than one output is active, an error message assumes a general nature.

If the consumers encounter a problem during auto mode, either a fault or error message is generated, depending on the severity. In the event of an error message, the controller enters stop mode (auto stop), and all consumers are switched OFF. On error acknowledgement, the controller restarts auto mode. If this error is not remedied, an error message again appears the next time this error is detected. An error encountered by the consumers in manual mode causes all of them to be switched OFF.

Factory settings for current measuring limits

Output	Maximum limit [mA]	Minimum limit [mA]
Compressor 1	5000	150
Compressor 2	5000	150
UV lamp	2000	150
Fan 1	3000	150
Fan 2	3000	150
Fan 3	600	5
Pump	3000	150
Dosing pump 1	800	5
Dosing pump 2	800	5
Dosing pump 3	800	5
Warning lamp	200	5
Reserve 24 V	300	5

9.11 Flexible input and output assignments

The menu  "Service" > "Cycle settings" > "Assign outputs" lets the user assign any function to any output. However, only one output can be assigned to one function, and only one function to one output. The controller software shows only the functions (e.g. current monitoring, operating menu, module settings), and not their assigned outputs.

The default input and output configuration is as follows:

KLcontrol.S	
Outputs	Inputs
X31 -> compressor 1	
X32 -> pump	
X12.7 -> dosing pumps 1 and 2, warning lamp	

KLcontrol.M	
Outputs	Inputs
X31 -> compressor 1	X12.9 -> user definable
X32 -> compressor 2	X12.11 -> user definable
X33 -> UV lamp	X20 -> user definable
X34 -> fan 1	
X35 -> fan 2	
X36 -> pump	
X12.1 -> dosing pump 1	
X12.3 -> fan 3	
X12.5 -> warning lamp	
X12.7 -> reserve 24 V	

9.12 Replacing the step motor valves with magnetic valves or pumps

If the step motor valves are to be replaced with magnetic valves, only the function for this valve need be assigned to the output (e.g. valve 1 -> X32). This communicates to the controller that the valve is no longer activating the step motor, but has been assigned to a regular output. The controller clocks this automatically with the compressor, instead of providing current permanently to the magnetic valve.

Assigning a valve function to another output causes the menu to generate a prompt (Yes/No) as to whether a pump is used. The answer "Yes" instructs the controller to clock the output with the compressor times over the cycle and suppress the compressors 1 and 2 for this T-step. Select this menu item again to reedit this setting.

9.13 Electrical connections



WARNING

Hazardous voltage

- Danger from electric shock. An electric shock can cause serious burns and life threatening injury.
- Only specialised electricians may be assigned to work on the electrical installations and to connect the plant to its power supply.
- Before all work on the electrical system, disconnect the controller from its power source and secure it against reactivation.
- On removal of the power supply, there may still be voltage across charged capacitors.
- Wait until the capacitors have discharged!

An onsite all-pole circuit breaker for the mains voltage must be used for the electrical connections. The controller for wastewater treatment plants may be operated in a switch cabinet only, which must comply with IP44 or NEMA 3 or higher. All electrical connections to the rear side of this controller must lie inside the switch cabinet.

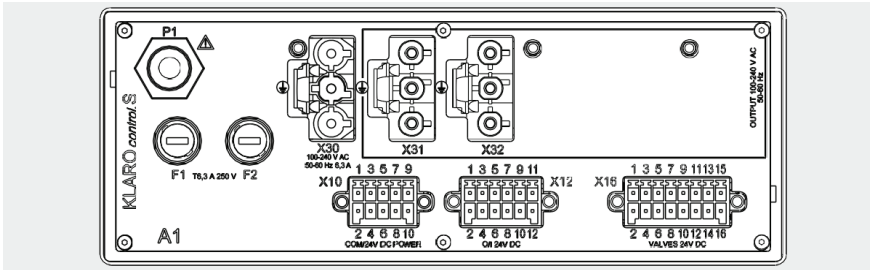

Figure 13 – Electrical connections for KLcontrol.S

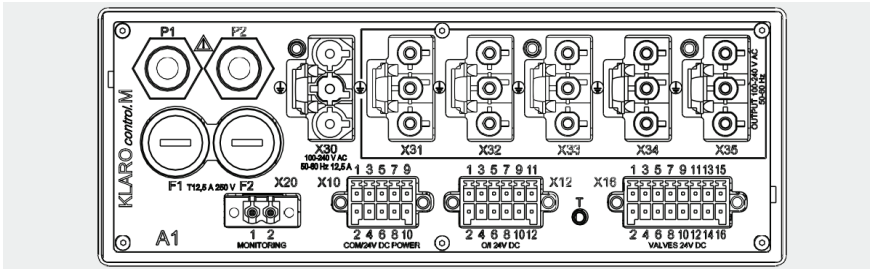



Figure 14 – Electrical connections for KLcontrol.M

9 Additional controller functions

On the KLcontrol, the centre X30 pin is connected to the protective earth of the electrical installation. This pin is labelled in addition with the symbol . Devices at the outputs X31–X35 are also connected via their centre pins to the protective earth of X30. These pins too are labelled with the symbol .

9.13.1 F1/F2 – fusing

There are two microfuses located on the rear of the control unit.

- KLcontrol.S: T6.3A / 250 V 5 x 20 mm Schurter 0034.3125 (type FST_5x20)
- KLcontrol.M: T12.5A / 250 V 5 x 20 mm Schurter 0001.2515 (type SPT_5x20)

Use only fuses of the same type and the specified current rating.

9.13.2 P1/P2 – pressure sensors

The pressure sensors serve to measure the level in the treatment tank and to confirm that the compressor is operating properly. Maximum rated pressure: 50 kPa.

The controller is fitted with one or two pressure sensors:

- KLcontrol.S: one pressure sensor.
- KLcontrol.M: two pressure sensors.

9.13.3 T – temperature sensor

The KLcontrol.M controller for wastewater treatment plants features an additional connection for an external temperature sensor.

9.13.4 X12 – 24 V digital inputs

- KLcontrol.S: no 24 V digital inputs.
- KLcontrol.M: three 24 V digital inputs.

The digital inputs are 24 V designs. The input and output status can be visualised on the display.

9.13.5 X12 – 24 V outputs

- The KLcontrol.S controller for wastewater treatment plants features a user definable 24 V output.
- The KLcontrol.M controller for wastewater treatment plants features four 24 V outputs for:
 - dosing pump 1
 - cooling fan
 - warning lamp
 - user definable

All 24 V outputs are protected against short circuiting and overload. A maximum and minimum current can be specified for each output. The total current is monitored during operation. In the

9 Additional controller functions

event of an error, the outputs are activated in turn as a measure to locate and diagnose the error, after which an error message appears on the display.

While the step motors are being activated, the remaining 24 V consumers are switched OFF. This helps to prevent overloading on the power supply and enable measurements of the step motor currents.

Pin	Description	Type
1	Dosing pump	Output
2	Earth	
3	Cooling fan (24 V)	Output
4	Earth	
5	Warning lamp	Output
6	Earth	
7	User definable (24 V)	Output
8	Earth	
9	Float switch	Input
10	Earth	
11	User definable	Input
12	Earth	

A total current of 1 A is provided for the 24 V outputs. This includes the 24 V output at X10. Make sure that this total current cannot be exceeded.

9 Additional controller functions

9.13.6 X16 – step motor outputs

Up to four step motors can be connected to the KLcontrol.S and KLcontrol.M controllers for wastewater treatment plants. The motor drivers used feature excess current control with signal output. The output delivers up to 1.6 A at 24 V.

Pin	Description	Pin	Description
1	Step motor 1-A	9	Step motor 3-A
2	Step motor 1-B	10	Step motor 3-B
3	Step motor 1-C	11	Step motor 3-C
4	Step motor 1-D	12	Step motor 3-D
5	Step motor 2-A	13	Step motor 4-A
6	Step motor 2-B	14	Step motor 4-B
7	Step motor 2-C	15	Step motor 4-C
8	Step motor 2-D	16	Step motor 4-D

9.13.7 X20 – contactor monitoring

- KLcontrol.S: no input to contactor monitoring.
- KLcontrol.M: one input to contactor monitoring

An optocoupler is used to detect alternating voltage > 80 Vac.

Pin	Description
1	L
2	N

If higher performance consumers are required, these can be supplied via a contactor. The increased load is then no longer borne by the controller. This contactor can be monitored via the input at the connector X20.

The output function needing to be monitored can be set in the menu  "Service". Contactor monitoring is deactivated when no output function has been selected. These settings are saved to nonvolatile EEPROM.

Activating contactor monitoring deactivates automatically the current monitor for this output, irrespectively of the current measuring limits set in the Service menu.

Monitoring activated for KLcontrol.M uses automatically the input X20.1. There is no contactor monitoring for KLcontrol.S.

9 Additional controller functions

The contactor is monitored with a defined debouncing time. Also contactors activated with 24 V can be used.

9.13.8 X30 – input voltage

The 100–240 V / 50–60 Hz range for the input voltage is monitored constantly. If these limits are exceeded, the outputs are no longer activated, and an error message appears. An AC 166 plug connector safeguards the correct polarity of the mains voltage.

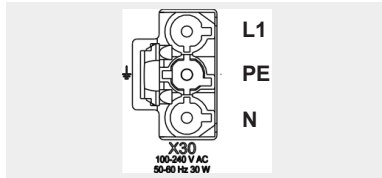

Figure 15 – X30 connection: AC 166 IN

9.13.9 X31/ X35 – 230 V outputs

The controller features on its rear side the 230 V outputs for the wastewater treatment consumers. The controller has been designed for installation in a switch box – its rear side is not protected against spray water!

All outputs are fitted with a common current sensor (total current monitoring) and common fusing.

A total current of 6.3 A (KLcontrol.S) or 12.5 A (KLcontrol.M) is provided for the 230 V outputs. Make sure that this total current cannot be exceeded.

- KLcontrol.S: 2 outputs for:
 - compressor
 - pump
- KLcontrol.M: 5 outputs for:
 - compressor 1
 - compressor 2
 - UV module
 - cooling fan
 - pump

9.14 X10 – other sensors / communication interface

The controller is fitted with an RS485 interface that can take frequency inverters or other sensors, e.g. for cloudiness, oxygen content, flow measurements, sludge measurements. The RS485 interface can interpret the JSON protocol.

10 Fault messages and rectification

Technical plant operation faults (failure of a consumer) are indicated both visually and acoustically. Pressing **[OK]** deactivates the control unit's acoustic fault signal for 10 minutes. The displayed error can be acknowledged only when the message is selected with the cursor key **[▲]** and **[OK]** is pressed.

If the power supply fails, an integrated non-mains-dependent power cut detector emits an alarm which alternates with a visual signal. If this happens, no acknowledgement can be performed.

The acoustic fault signal can be deactivated in advance in the menu  "Settings" > "Buzzer" > "Power failure". Please note: Edits to this setting are not reset automatically.

10.1 Power failure

The controller **KLcontrol** for wastewater treatment plants comes with a wide-range power supply delivering alternating voltages of 100–240 V at a frequency of 50–60 Hz. Voltage failure within this range can be safely offset.

In addition, all relevant data are saved to nonvolatile EEPROM in the controller. In other words, these saved data can be retrieved after a power failure or controller reset (if undamaged). The following data are saved to EEPROM:

- general data (UI language, treatment process settings, current T-step, E number, pressure measuring method, holiday period, etc.)
- calibration data and settings for both pressure sensors
- event memory data (information, error, fault)
- current cycle settings adopted from the cycle editor
- operating hours (valves, UV lamp, phosphate pump, compressor)

10.2 events in tabular form

events are sorted in ascending order of urgency and divided into information (**H.xx**), faults (**S.xx**), and errors (**F.xx**).

All occurred events appear on the home screen. The event is deleted at **[OK]** in the user menu. An ongoing event (fault or error only) cannot be deleted. After acknowledgement, the entry remains in the log book.

10.2.1 Information messages

Information messages refer the operator, service personnel, etc., to mandatory actions. The program continues running normally in the background.

10 Fault messages and rectification

No.	Message	Action	Description/remedy
H.1	Service needed	Display	Message from service timer: Service needed
H.2	Service acknowledged	Log book entry	Acknowledging the service timer generates a message
H.3	Service completed	Log book entry	The technician can confirm in the Service menu that service is completed
H.4	UV operating hours	Display	The UV lamp has reached its maximum operating hours (KLcontrol.M only)
H.5	Not used		
H.6	System reset	Log book entry	The system is restarted (software update, power failure, software error)
H.7	Temperature threshold 2	Display	The set temperature threshold 2 has been exceeded (KLcontrol.M only)
H.8	Cycle overflow	Log book entry	An edit to the cycle settings has caused a cycle overflow
H.9	Cycle setting	Log book entry	The cycle settings have been edited
H.10	Manual mode	Log book entry	Manual mode has been activated manually
H.11	Supply OK	Display	Supply voltage reinstated. This appears when the mains voltage has failed, but the buffer battery can still deliver backup power

10 Fault messages and rectification

10.2.2 Fault messages

Fault messages appear when the system is not operating properly and needs to be checked. This may require the expertise of a specialist. The program continues running in the background, possibly with restrictions. The status LED lights up yellow, and also a warning tone sounds. Confirmation deactivates the warning tone temporarily. Not until after the fault has been remedied can the event be acknowledged at [OK]. An entry is made in the log book.

No.	Message	Description/remedy
S.1	Overflow warning	The maximum level (setting) has been exceeded.
S.2	Minimum level	The level has fallen below the 40 cm minimum
S.3	Pressure sensor 1	Pressure sensor 1 has encountered a problem. The cycle continues running without level measuring. Compressed air monitoring and the pressure switches are no longer available.
S.4	Pressure sensor 2	Pressure sensor 1 has encountered a problem. Compressed air monitoring and the pressure switches are no longer available (KLcontrol.M only).
S.5	Not used	
S.6	Cooling fan 1	Fan 1 short circuit or break (KLcontrol.M only)
S.7	Cooling fan 2	Fan 2 short circuit or break (KLcontrol.M only)
S.8	Cooling fan 3	Fan 3 short circuit or break (KLcontrol.M only)
S.9	Temperature sensor	Temperature sensor defective or not connected.
S.10	USB	A problem has been encountered with the USB memory stick (e.g. corrupted file system or memory full).
S.11	Min. pressure V1	Compressed air monitoring at valve 1 has returned a value less than the teach-in limits with consideration to the deviation and tolerance settings.
S.12	Max. pressure V1	Compressed air monitoring at valve 1 has returned a value greater than the teach-in limits with consideration to the deviation and tolerance settings.
S.13	Min. pressure V2	Compressed air monitoring at valve 2 has returned a value less than the teach-in limits with consideration to the deviation and tolerance settings.
S.14	Max. pressure V2	Compressed air monitoring at valve 2 has returned a value greater than the teach-in limits with consideration to the deviation and tolerance settings.
S.15	Min. pressure V3	Compressed air monitoring at valve 3 has returned a value less than the teach-in limits with consideration to the deviation and tolerance settings.
S.16	Max. pressure V3	Compressed air monitoring at valve 3 has returned a value greater than the teach-in limits with consideration to the deviation and tolerance settings.

10 Fault messages and rectification

S.17	Min. pressure V4	Compressed air monitoring at valve 4 has returned a value less than the teach-in limits with consideration to the deviation and tolerance settings.
S.18	Max. pressure V4	Compressed air monitoring at valve 4 has returned a value greater than the teach-in limits with consideration to the deviation and tolerance settings.
S.19	Pressure compressor	Compressed air monitoring for the buildup of compressor pressure has returned a value less than the teach-in limits with consideration to the deviation and tolerance settings.
S.20	XX d until plant stops	The plant is stopped automatically after 182 days (without activation code). For the last 30 days, a message appears giving the remaining number of days.
S.21	C-canister empty	Carbon canister monitoring signals empty.
S.22	P-canister empty	Phosphate canister monitoring signals empty.
S.23	Chlorine-canister empty	Chlorine canister monitoring signals empty.

10.2.3 Error messages

Error messages appear when the system is not operating properly and needs to be checked.

This may require the expertise of a specialist. The program is stopped as a measure to prevent damage. The status LED lights up red, and also a warning tone sounds. Confirmation deactivates the warning tone temporarily. Not until after the error has been remedied can the event be acknowledged at [OK]. An entry is made in the log book.

No.	Message	Description/remedy
F.1	Compressor 1	Short circuit or break at the output for compressor 1
F.2	Compressor 2	Short circuit or break at the output for compressor 2
F.3	UV lamp	Short circuit or break at the output for UV lamp
F.4	Pump	Short circuit or break at the output for pump
F.5	Dosing pump 1	Short circuit / break at the output for dosing pump 1
F.6	Dosing pump 2	Short circuit / break at the output for dosing pump 2
F.7	Dosing pump 3	Short circuit / break at the output for dosing pump 3
F.8	Warning lamp	Short circuit or break at the output for warning lamp
F.9	Reserve 6W	Short circuit or break at the reserve output
F.10	Not used	
F.11	Valve 1	Short circuit or break at the output for valve 1
F.12	Valve 2	Short circuit or break at the output for valve 2
F.13	Valve 3	Short circuit or break at the output for valve 3

10 Fault messages and rectification

F.14	Valve 4	Short circuit or break at the output for valve 4
F.15	Power supply	The supplied voltage is defective. As a measure to protect its components and lessen the load on the buffer battery, the plant stops the cycle.
F.16	Temperature threshold 3	The set temperature threshold 3 has been exceeded. This message is cleared automatically as soon as the temperature returns within its normal range.
F.17	Not used	
F.18	Not used	
F.19	Not used	
F.20	Not used	
F.21	EEPROM	An error has occurred on reading out or writing to the internal memory. The controller can no longer be expected to operate properly.
F.22	Error 230V	General mains output error. If more than one mains output is active at the same time, the controller is unable to derive from the total current measurements the precise location of this error. There is a short circuit or break at one or more mains outputs. The defect may be located when each output is activated in manual mode.
F.23	Error 24V	General 24 V output error. If more than one output is active at the same time, the controller is unable to derive from the total current measurements the precise location of this error. There is a short circuit or break at one or more 24 V outputs. The defect may be located when each output is activated in manual mode.
F.24	Input required	The plant is stopped automatically after 182 days (without activation code). After this period, the plant discontinues operations. Not until the code provided by the manufacturer has been entered in the Service menu can the plant be put back into operation. The message then clears automatically.

10 Fault messages and rectification

10.3 Unusual water levels– remedying a fault

Observation	Possible cause	Rectification
The water level in the pre-treatment section is unusually high, but is normal in the aeration section.	<ul style="list-style-type: none"> • Lifter at valve 1 not activating. • The pump time set for lifter 1 is too short. • The feed lifter is blocked. • The air supply to the feed lifter is leaking. 	<ul style="list-style-type: none"> • In manual mode, activate valve 1 and check function of lifter. • Have time for valve 1 extended by service company. • Allow pre-treatment section to be pumped empty and clean lifter. • Allow pre-treatment section to be pumped empty and seal hose connections.
The water level in the pre-treatment section and aeration basin is unusually high.	<ul style="list-style-type: none"> • Plant running in holiday mode. • Plant running continuously in cycle pause. • Control unit settings are incorrect. • The discharge lifter is blocked. • The air hose to the discharge lifter is leaking. • Flooding in the discharging system is not allowing water to drain from the plant.. • Control unit is defective. 	<ul style="list-style-type: none"> • Exit holiday mode (see section) • Have control unit settings checked by a maintenance specialist • Allow SBR reactor to be pumped empty and clean lifter. • Allow SBR reactor to be pumped empty and seal hose connections. • Wait for flooding to drain away. • Contact maintenance company.
The plant smells, the cleaned wastewater is cloudy and/or discoloured	<ul style="list-style-type: none"> • Too little air is being drawn into the plant. • Aeration on one side only due to defective membrane unit 	<ul style="list-style-type: none"> • Have aeration time extended by service company. • Check aeration pattern, contact maintenance company.
Aeration pattern is one-sided and/or large air bubbles are forming in some areas	<ul style="list-style-type: none"> • Membrane unit defective • Seal on aerator bar leaking 	<ul style="list-style-type: none"> • Contact maintenance company. • Contact maintenance company.
Magnetic valves switching unusually loudly	<ul style="list-style-type: none"> • Valve seat of magnetic valve is dirty. 	<ul style="list-style-type: none"> • Screw open and clean magnetic valve

10.4 Possible faults on step motor valves

Observation	Possible cause
Valve does not close.	<ul style="list-style-type: none">• Rated voltage not present• Motor winding defective• Gears defective• Valve seized
Valve does not open.	<ul style="list-style-type: none">• Rated voltage not present• Motor winding defective• Gears defective• Valve seized

11 Disposing of the controller

The controller bears a WEEE symbol. This means that electrical and electronic products no longer in use may not be disposed of in household waste. Introduce the device to a collecting point provided by your community (e.g. recycling centre), and contribute actively to the protection of the environment.



12 Declarations, attestations, certificates

12.1 Original EC declaration of conformity for wastewater treatment system in plastic tank

Make: Otto Graf GmbH Kunststoffzeugnisse
Carl-Zeiss-Str. 2-6
DE-79331 Teningen
Tel. +49 7641 589-0
Fax +49 7641 589-50
www.graf.info

hereby declares that the **one2clean plus**, a wastewater treatment system in plastic tanks for 4 to 50 PE meets the requirements of the following directives:

- | | |
|--------------------|---|
| 2011/305/EU | Regulation no. 305/2011 of the European Parliament and of the Council of 9 March 2011 on defining harmonised conditions for marketing construction products. |
| 2006/42/EC | Directive of the European Parliament and of the Council of 17 May 2006 on machines and changes to Directive 95/16/EC. |
| 2014/35/EU | Directive 2014/35/EU of the European Parliament and of the Council of 26 February 2014 on the harmonisation of the laws of Member States relating to electrical equipment designed for use within certain voltage limits. |
| 2014/30/EU | Directive 2014/30/EU of the European Parliament and of the Council of 26 February 2014 on the harmonisation of the laws of Member States relating to electromagnetic compatibility (EMC). |

The following harmonised standards were applied:

- | | |
|--------------------------------|---|
| EN 12566-3:2005+A2:2013 | Small wastewater treatment systems for up to 50 PT – Part 3: Packaged and/or site assembled domestic wastewater treatment plants. |
| EN 60204-1/A1: 2009 | Electrical equipment of machines – Part 1: General requirements. |
| EN ISO 13849-1: 2008 | Safety of machinery – Safety-related parts of control systems – Part 1: General principles for design. |

This EC declaration of conformity ceases to apply if the product is modified without consent.

Responsible for documentation: Otto Graf GmbH

Teningen, 1 April 2021

pp Ralf Oestreicher
Product Range Manager
– DIY / Garden / Wastewater Technology –

12.2 Declaration of performance

Declaration of performance

one2clean plus



Nr. 105/Translation

1. Unique identification code of the product-type	One2clean plus
2. Type, batch or serial number or any other element allowing identification of the construction product as required pursuant to Article 11(4)	one2clean plus 3-18 Inhabitants Type size and serial number on control cabinet type plate
3. Intended use or uses of the construction product, in accordance with the applicable harmonised technical specification, as foreseen by the manufacturer	EN 12566-3:2005+A2:2013: Prefabricated and/or site assembled domestic wastewater treatment plants
4. Name, registered trade name or registered trade mark and contact address of the manufacturer as required pursuant to Article 11(5)	Otto Graf GmbH Kunststoffzeugnisse Carl-Zeiss-Str. 2-6 79331 Teningen Germany
5. System or systems of assessment and verification of constancy of performance of the construction product as set out in Annex V	System 3
6. Name and identification number of the notified body	PIA - Prüfinstitut für Abwassertechnik GmbH - NB 1739

7. Declared performance (with regard to the harmonised standard EN 12566-3:2005+A2:2013)		
	Performance	Test report No.
Cleaning capacity	Nominal organic daily dirt cargo (BOD ₅) = 0.06 kg/d per PE. Nominal daily inflow (Q ₀) = 150 l per PE.	
Treatment efficiency	COD: 94,2 % 43 mg/l BOD ₅ : 98,0 % 7 mg/l NH ₄ -N: 98,3 % 0,5 mg/l N _{tot} : 87,0 % 8 mg/l SS: 98,3 % 14 mg/l	PIA2014-216B14.01
Watertightness	Passed	PIA2016-WD-1509-1050.01 (Carat RS) PIA2010-WD-AT1005-1027 (Carat XL) PIA2015-WD-1502-1010.01 (Carat XXL)
Stability	Passed	PIA2016-ST-PIT-1509-1050.01 (Carat RS) PIA2010-ST-PIT-1005-1027 (Carat XL) PIA2013-ST-CAL-1302-1010 (Carat XXL)
Durability	Passed	PIA2016-DH-1509-1050.01 (Carat RS) PIA2010-ST-PIT-1005-1027 (Carat XL) PIA2013-ST-CAL-1302-1010 (Carat XXL)
Reaction to fire	Class E	PIA2016-RF-1509-1050.01 (Carat RS) KB-Hoch-121316 (Carat XL) PIA2013-ST-CAL-1302-1010 (Carat XXL)
Release of dangerous substances	NPD	
8. The performance of the product identified in points 1 and 2 is in conformity with the declared performance in point 7. This declaration of performance is issued under the sole responsibility of the manufacturer identified in point 4.		

Signed for and on behalf of the manufacturer by:

i.V. Ralf Oestreicher
Team leader, product management
Teningen, 26.08.2020

13 Annex I: Template for weekly / monthly check notes

Note down parameters monthly, mains water consumption yearly.

Date of check	Sludge leaking?		Cloudiness / discoloration?		Supply / discharge blocked?		Air filter checked?		Operating hours counter					Mains water consumption	
	Yes	No	Yes	No	Yes	No	Yes	No	Valve 1	Valve 2	Valve 3	Valve 4	Total		

13 Annex I: Template for weekly / monthly check notes

Date of check	Sludge leaking?		Cloudiness / discoloration?		Supply / discharge blocked?		Air filter checked?		Operating hours counter					Mains water consumption	
	Yes	No	Yes	No	Yes	No	Yes	No	Valve 1	Valve 2	Valve 3	Valve 4	Total		

13 Annex I: Template for weekly / monthly check notes

Date of check	Sludge leaking?		Cloudiness / discoloration?		Supply / discharge blocked?		Air filter checked?		Operating hours counter					Mains water consumption	
	Yes	No	Yes	No	Yes	No	Yes	No	Valve 1	Valve 2	Valve 3	Valve 4	Total		

14 Maintenance log for GRAF wastewater treatment systems

Location (address): _____

Maintenance company: _____ Date of maintenance: _____

Serial number: _____ Order no.: _____

Plant size: _____ PE Actual Connection _____ PE

Operator's name: _____ Customer no.: _____

Street: _____ Town/city, postcode: _____

Installed by: _____ Commissioning: _____

Will the plant process commercial wastewater too? No

Restaurant without kitchen Restaurant with kitchen Other _____

Grease separator present, NG _____ Emptying needed

Function check of plant parts important to operation:

Aeration / valve 1 (blue)

Feed / valve 2 (red)

Excess sludge lifter / valve 3 (white)

Clear water lifter / valve 3 (black)

Power cut indicator

Air inlet / aeration: moderate

intensive, circulation clearly visible

Aerator pattern / aeration: fine bubbles

even

Comments: _____

Sludge accumulator + buffer:

Sludge height: _____ cm Floating sludge height: _____ cm

The operator should arrange for the cesspit to be emptied.

SBR reactor:

Oxygen concentration: _____ mg/l (normally approx. 4-6 mg/l, at least 2 mg/l)

Sludge as proportion of volume: _____ ml/l (maximum 700 ml/l)

Comments: _____

Control unit:

Control unit type: _____ Σ operating hours: _____

Aeration (valve 1): _____ Discharge (valve 2): _____

Excess sludge reservoir (valve 3): _____

14 Maintenance log for GRAF wastewater treatment systems

Comments: _____

Blower:

- Blower type: _____ Blower OK
 Change the slats (slat length: _____ mm) Change the membranes
 Filter change Cooling fan OK

Comments: _____

Time of sampling:

Date: _____ Time: _____

Sampling site: _____ Sampling shaft SBR chamber

Sample transport: _____ cooled 4°C frozen

Air temperature:	_____ °C	Water temperature:	_____ °C	
odour	<input type="checkbox"/> none <input type="checkbox"/> weak <input type="checkbox"/> strong	<input type="checkbox"/> rotten <input type="checkbox"/> earthy		
Colouring	<input type="checkbox"/> none <input type="checkbox"/> weak <input type="checkbox"/> strong	<input type="checkbox"/> beige <input type="checkbox"/> brown		
Cloudiness	<input type="checkbox"/> none <input type="checkbox"/> weak <input type="checkbox"/> strong	<input type="checkbox"/> opaque		
Floating matter	<input type="checkbox"/> none <input type="checkbox"/> a little <input type="checkbox"/> a lot			

Activated sludge _____ kg SOL / m³ P_{total} _____ ml / l

Substances that can settle _____ ml / l pH _____

BOD₅ _____ ml / l COD _____ ml / l

NH₄-N _____ ml / l N_{tot} _____ ml / l

Additional comments:

- Operating log available. Maintenance noted in the log.
 Programming modified: _____

 Fault rectified: _____
 Additional comments: _____

To be arranged by the operator:

- The operator is asked to note the substances which must not enter the plant (see operating manual).
 Pit is overflowing, operator must discharge content.
 Sludge removal

